

-948/26

Supplement to the instruction
manual and parts list for the
series **1180, 3701, 5483**

The reprinting, copying or translation of PFAFF Instruction Manuals, whether in whole or in part, is only permitted with our previous authorization and with written reference to the source.

**PFAFF Industriesysteme
und Maschinen AG**

Hans-Geiger-Str. 12 - IG Nord
D-67661 Kaiserslautern

	Page
Contents	Page
1 Proper use	4
1.01 Using standard presser feet	4
2 Controls	5
2.01 Puller functions	5
2.02 Aligning the puller	5
2.03 Control panel	6
2.03.01 Screen displays	6
2.03.02 Function keys	6
2.03.03 Selecting and altering parameters	9
2.03.04 Selecting the user level	10
3 Commissioning	11
3.01 Basic position of the machine drive	11
3.02 Testing the function of the start inhibitor	12
4 Setting up	13
4.01 Entering the puller feed stroke (stitch length)	13
4.02 Setting the puller pressure	13
4.03 Entering the maximum speed	14
4.04 Entering the start and end backtacks	14
4.05 Setting the stitch counting function for the bobbin thread control	15
5 Sewing	1
5.01 Manual sewing	1
5.02 Programmed sewing	2
5.03 Error messages	3
6 Parameter Settings	16
7 Software-Update	21
8 Reset / Kaltstart	22
9 Partslist	23
10 Circuit diagrams	24

1 Proper use

With the **puller** the workpiece is fed continuously, which makes it possible to sew to a great extent without shifting and puckering. The puller's linear motor enables an individual clearance space between the needle plate and the puller roller.

All adjustments, such as e.g. puller feed stroke, puller roller clearance etc. are carried out by altering the parameter values, see **Chapter 2.03.03 Selecting and altering parameters**.



Any use of these machines which is not approved by the manufacturer shall be considered as improper use! The manufacturer shall not be liable for any damage arising out of improper use! Proper use shall also be considered to include compliance with the operation, adjustment, service and repair measures specified by the manufacturer!

1.01 Using standard presser feet

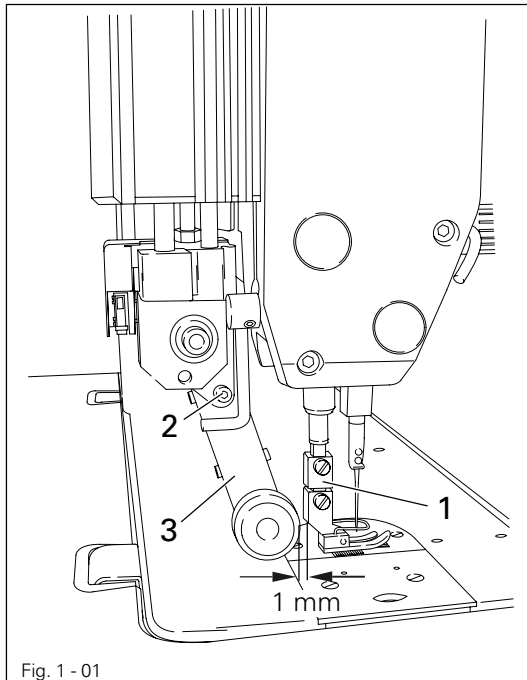

- With the adapter 1 which belongs to the accessories, standard presser feed can also be used (Ordering number 91-154 790-22).
- Mount adapter 1 as shown in **Fig. 1-01**.
- Loosen screw 2 and push puller arm 3 back.
- Screw the presser foot onto adapter 1.
- Adjust puller arm 3 so that there is a clearance of approx. **1 mm** between the puller roller and the presser foot.
- Tighten screw 2.



When using the adapter, the height of the puller roller must be adjusted as described in **Chapter 2.02**.

2 Controls

2.01 Puller functions

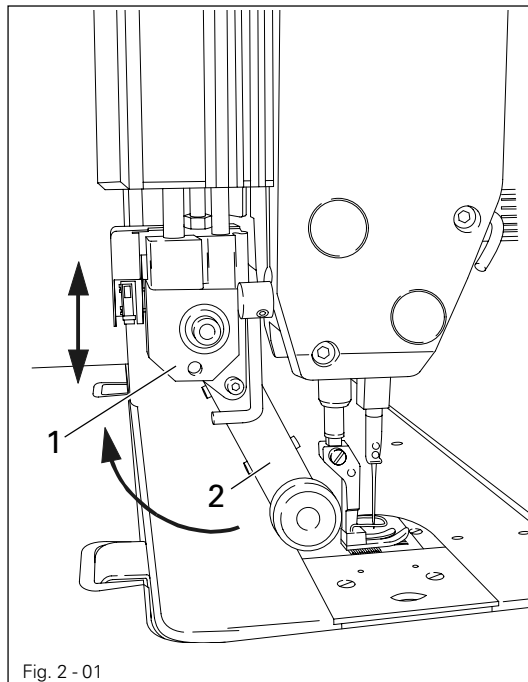

Fig. 2 - 01

Engaging/disengaging the puller

- Raise the puller drive unit 1 until it locks into place and swing puller arm 2 back as far as possible. To engage the puller, follow the instructions in the reverse order.

Switching the puller on/off

- The puller is automatically switched on or off when the puller unit is engaged or disengaged.

Setting the puller feed motion

- The feed motion of the puller is set by means of parameters (see Chap. 1.06 **Parameter settings** and the Motor Instruction Manual)

2.02 Aligning the puller

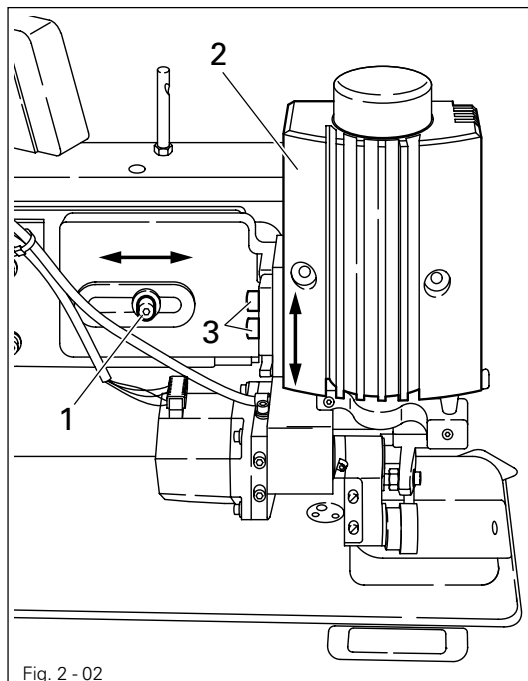

Fig. 2 - 02

Puller crosswise to sewing direction

- Loosen screw 1.
- Align puller 2 to the seam.
- Tighten screw 1.

Height of the puller roller

- Loosen screw 3
- Align puller 2, so that there is a clearance of approx. 0.3 mm between the puller roller 4 and the cloth plate.
- Tighten screw 3.

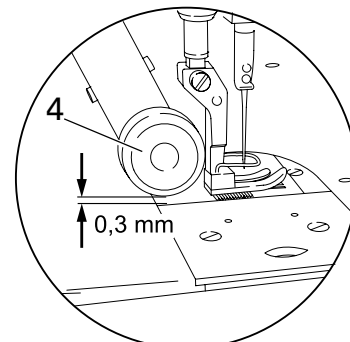

2.03 Control panel

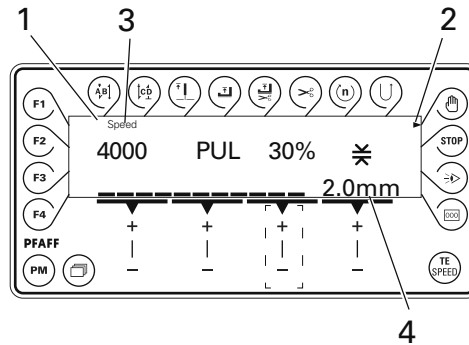

The control panel consists of display 1 and the function keys described below. Display 1 consists of a two-row, alpha-numerical display with 16 symbols per row. The texts 3 show the respective status of the function keys and the operating modes of the machine. During the power-on phase the control panel automatically switches on all LCD segments and the horn. The number of the version of the installed software then appears on the display, until the higher-ranking control unit sends commands to the control panel.

2.03.01 Screen displays

- Activated functions are displayed with a triangular marking 2 below or next to the respective function key.
- In the sewing mode all relevant sewing data is displayed and these can be changed directly, depending on the status of the machine, see also **Chapter 5 Sewing**.
- During the parameter input the selected parameter number with the corresponding value is displayed, see **Chapter 2.02.03 Selecting/changing parameters**.

2.03.02 Function keys

The function keys described below are used basically to switch machine functions on and off.

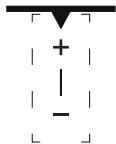

If a corresponding value has to be set for the activated function, this is carried out with the corresponding **+/- key**. By pressing and holding the corresponding **+/- key**, the appropriate numerical value 4 is changed slowly to begin with. If the corresponding **+/- key** is held down longer, the values change more quickly.



Start backtacks

If this key is pressed, the backtacks at the beginning of the seam (start backtacks) are switched on or off. The number of forward stitches (A) or reverse stitches (B) for the start backtacks can be changed by pressing the **+/- key** underneath. To convert from double backtack to single backtack set the corresponding number of stitches at zero.



End backtacks

- If this key is pressed, the backtacks at the end of the seam (end backtacks) are switched on or off. The number of reverse stitches (C) or forward stitches (D) can be changed by pressing the +/- key underneath. To convert from double backtack to single backtack set the corresponding number of stitches at zero.



Needle position

- If this key is pressed the corresponding function is switched on or off. When the function is switched on, the needle positions at t.d.c. after sewing stops.



Foot position after stop

- If this key is pressed the corresponding function is switched on or off. When the function is switched on, the presser foot is raised after sewing stops.



Foot position after trimming

- If this key is pressed the corresponding function is switched on or off. When the function is switched on, the presser foot is raised after thread trimming.



Thread trimmer

- If this key is pressed the thread trimming function is switched on or off.



Speed (only in programmed sewing)

- If this key is pressed the corresponding function is switched on or off. In the seam program the speed is not dependent on the pedal. When the function is switched on, the speed cannot be adjusted by pedal. Sewing can only be carried out at the set maximum speed.
- If the function is switched off, the speed up to maximum speed is adjusted by the pedal.



Reverse sewing

- If this key is pressed the corresponding function is switched on or off. When the function is switched during programmed sewing, the corresponding seam section is sewn in reverse.



Manual seam (only in programmed sewing)

- If this key is pressed the machine switches to manual sewing. When the function is switched on, the move to the next seam section is not carried out by stitch counting or sensor, but manually with the use of the pedal (position "-2").



Stop

- If this key is pressed the corresponding function is switched on or off. When the function is switched on, the machine stops automatically at the end of a seam section.



Sensor

- In manual sewing the number of compensating stitches from the point where the photocell is light to the end of the seam can be set under parameter 111, and in programmed sewing directly.



Stitch counting

- If this key is pressed the corresponding function is switched on or off. When the function is switched on, the machine moves to the next seam section after sewing the number of stitches entered.



TE/Speed

- In the programmed sewing mode, the number of stitches is entered by stitching them off.
- If this key is pressed once, the machine changes to parameter input.
- If this key is pressed twice (within 5 seconds) the machine changes to stitch input.



Scrolling

- If this key is pressed in the programmed sewing mode, the machine scrolls through the input menus on the display.



PM

- If this key is pressed the programmed sewing function is switched on or off. When the function is switched on, the letters "PM" appear on the display of the control panel. The parameters related to the program are shown in the alpha-numerical part of the display.

F1

No function assigned

F2

No function assigned

F3

No function assigned

F4

No function assigned

2.03.03 Selecting and altering parameters

- Switch on the machine.
- Press the **TE/Speed** key to call up the parameter input function.

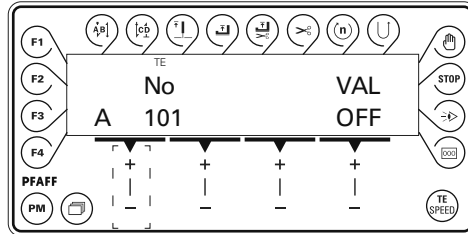

- No** ● By pressing the corresponding +/- key select the desired parameter group, e.g. "600".

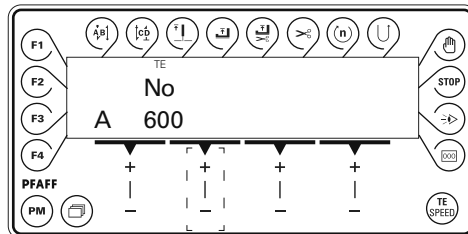

- No** ● By pressing the corresponding +/- key select the desired parameter, e.g. "660" for the bobbin thread monitoring function.

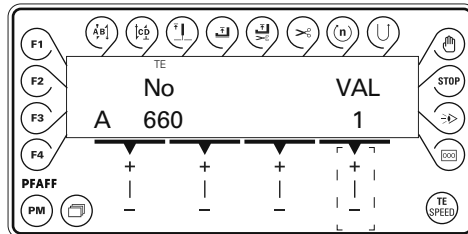

- VAL** ● By pressing the corresponding +/- key set the desired value for the parameter selected, e.g. "2" for the "bobbin rest thread counter on" function.

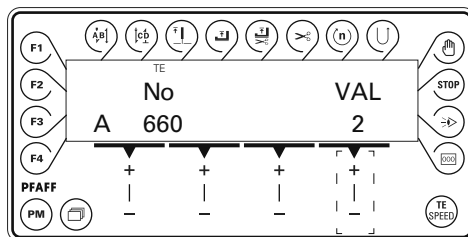

- Press the **TE/Speed** key to take over the value and change to the sewing mode.

2.03.04 Selecting the user level

- Switch on the machine.
- Press the **TE/Speed** key to call up the parameter input function.

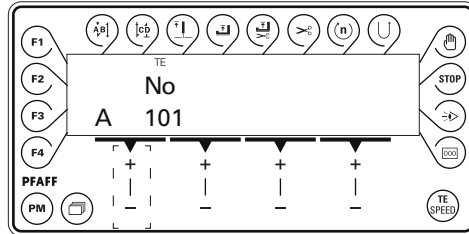

- No** ● By pressing the corresponding +/- key select the parameter group "700".

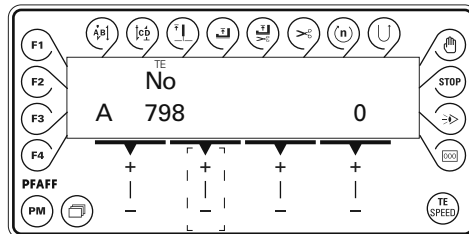

- No** ● By pressing the corresponding +/- key select the parameter "798".

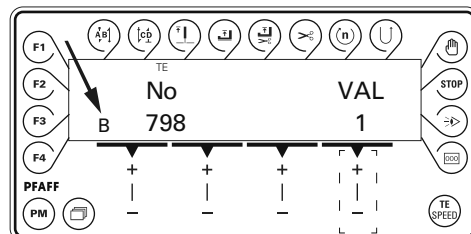

- VAL** ● By pressing the corresponding +/- key select the desired user level:
 - "0" = operator level A
 - "1" = technician level B
 - "11" = service level C

The respective level is displayed on the screen. (see arrow)



- Press the **TE/Speed** key to take over the value and change to the sewing mode.

3 Commissioning

3.01 Basic position of the machine drive

- Switch on the machine.

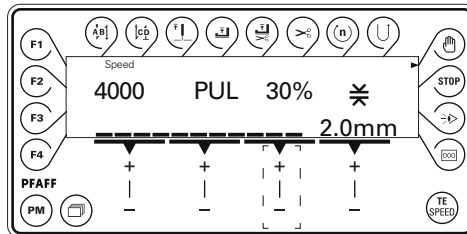

- Press the **TE/Speed** key to call up the parameter input function.
- Select the technician level **B** (value "1") with parameter "798", see Chapter 2.03.04 **Selecting the user level**.

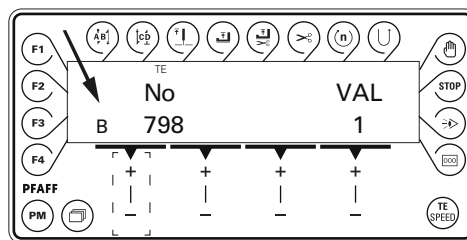

- No** ● By pressing the corresponding +/- key select the parameter group "700".

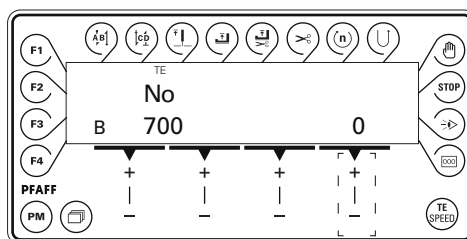



- Sew a stitch by operating the pedal.
- Turn the balance wheel in the direction of sewing until the needle point is level with the top edge of the needle plate.

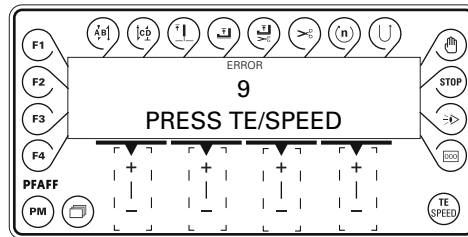

- Press the **TE/Speed** key to take over the setting and to conclude the input.

3.02 Testing the function of the start inhibitor



- Switch the machine on at the main switch and tilt back the sewing head. The error message "9" must appear on the control panel.
- If the message does not appear, check the setting of the safety switch (in the machine instruction manual).
- Set the sewing head upright again and acknowledge the error message by pressing the  TE/Speed key. The machine is ready for operation again.

4 Setting up

4.01 Entering the puller feed stroke (stitch length)

- Switch on the machine.

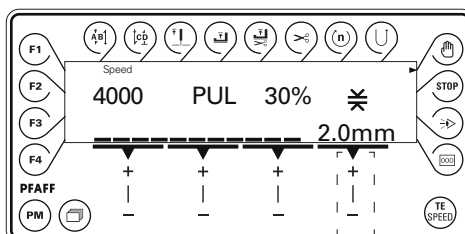

- ✂ ● Enter the feed stroke by pressing the corresponding +/- key.



The puller feed stroke setting must match the stitch length setting of the basic machine!

4.02 Setting the puller pressure

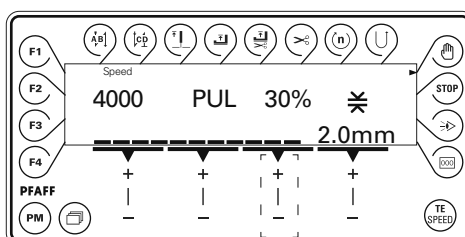

- Switch on the machine.
- Set the desired puller pressure by pressing the corresponding +/- key.
The value for the current puller pressure (in %) can be read on the display.

4.03 Entering the maximum speed

- Switch on the machine.

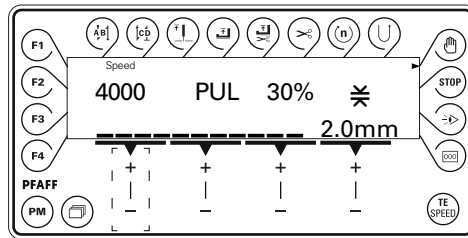

- Enter the maximum speed by pressing the corresponding +/- key.



The max. speed is limited with parameter 607.

4.04 Entering the start and end backtacks

- Switch on the machine.

2 x 

- Press the **TE/Speed** key twice to select the input menu for start and end backtacks.

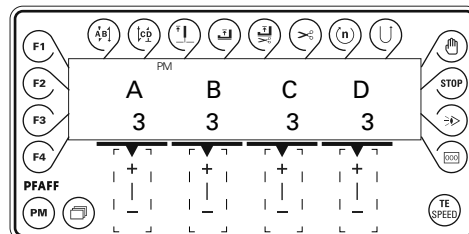

- A ● By pressing the corresponding +/- key select the desired value for the number of forward stitches (A) of the start backtack.
- B ● By pressing the corresponding +/- key select the desired value for the number of reverse stitches (B) of the start backtack.
- C ● By pressing the corresponding +/- key select the desired value for the number of reverse stitches (C) of the end backtack.
- D ● By pressing the corresponding +/- key select the desired value for the number of forward stitches (D) of the end backtack.



In the programmed sewing mode it is possible to call up the input menu for start and end backtacks by pressing the **scroll** key, see **Chapter 5.02 Programmed sewing**.

4.05 Setting the stitch counting function for the bobbin thread control

- Switch on the machine.
- Press the **TE/Speed** key to call up the parameter input function.

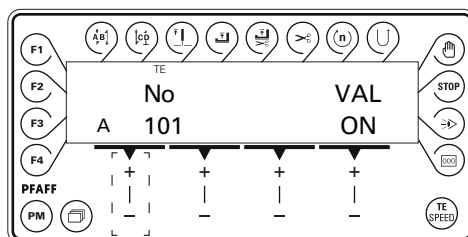

- No** ● By pressing the corresponding +/- key select the parameter "760".

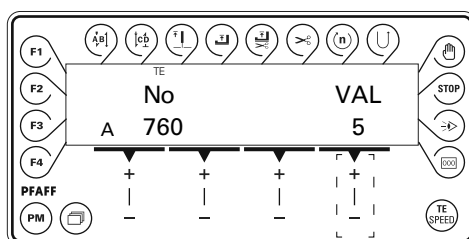

- VAL** ● Press the corresponding +/- key to set the number of remaining stitches, which can still be sewn after recognition by the bobbin thread control function. The selected value is multiplied by **10*** or **200**** and the result is the number of stitches. Example display $5 \times 200^{**} = 1000$ stitches. The setting depends among other things on the thread strength.



- If the **TE/Speed** key is pressed, the value is taken over and the machine changes into the sewing mode.



The bobbin thread rest counter can only be used, if parameter "660" is set at value "1" or "2".

* If for parameter 660 the value is "1", the multiplier is **10**

** If for parameter 660 the value is "2", the multiplier is **200**

5 Sewing

In the sewing mode all relevant adjustments for the sewing operation are shown on the display and can be altered directly. Functions can be switched on and off by pressing the key.





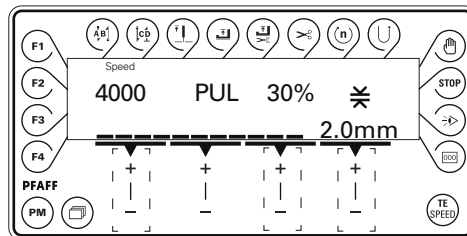

PM In this mode a difference is made between **manual sewing** and **programmed sewing**. To change from manual to programmed sewing, press the **PM** key. In programmed sewing the text "PM" appears on the display.

5.01 Manual sewing

After the machine has been switched on, the maximum speed, the puller feed stroke and the puller pressure can be adjusted with the corresponding +/- keys.



Further functions in manual sewing, also see **Chapter 2.02.02 Function keys:**

- | | | | |
|---|-------------------------------|---|---|
|  | Start backtacks on/off |  | Presser foot raised at end of seam on/off |
|  | End backtacks on/off |  | Thread trimming on/off |
|  | Needle position raised on/off |  | Sensor on/off |
|  | Presser foot raised on/off | | |



On the basic machine the stitch length is adjusted with the balance wheel. The stitch length for the puller is adjusted on the control panel

5.02 Programmed sewing

In the programmed sewing mode 99 programs, each with 9 seam sections and 999 stitches, can be programmed.

The fixed programs are used for the quick and easy production of seams with different numbers of stitches. The pedal setting „0“ is used to switch to the next seam section.

PM



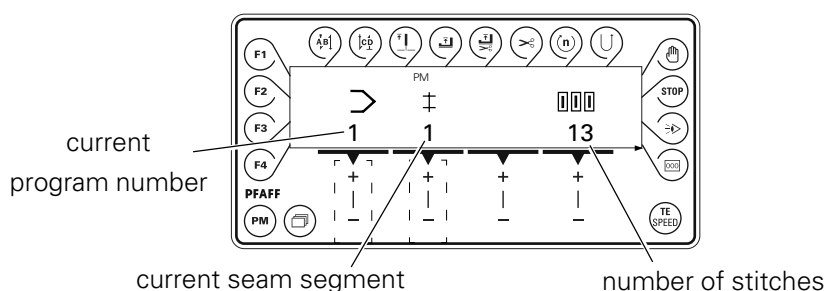



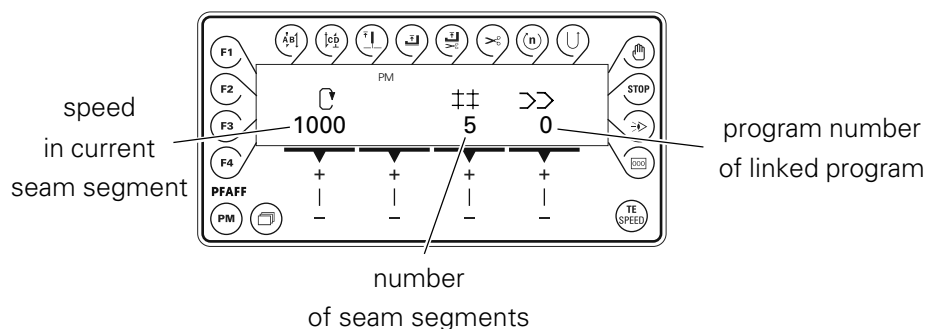





After the machine has been switched on and the programmed sewing mode has been selected with the **PM** key, the display appears for selecting the program number, seam section and number of stitches.



With the **scroll** key other menus can be selected for entering the values for start and end backtacks and the maximum speed in the corresponding seam section.



Further functions in programmed sewing, also see **Chapter 2.02.02 Function keys:**

- | | | | |
|---|--|---|---------------------------------|
|  | Start backtacks on/off |  | Seam section speed on/off |
|  | End backtacks on/off |  | Reverse sewing direction on/off |
|  | Needle position raised on/off |  | Manual sewing on/off |
|  | Presser foot raised on/off |  | Stop on/off |
|  | Presser foot raised after thread trimming on/off |  | Sensor on/off |
|  | Thread trimming on/off |  | Stitch count on/off |

5.03 Error messages

If a fault occurs, the text "ERROR" appears on the display, together with an error code and short instructions. An error message is caused by incorrect settings, faulty elements or seam programs as well as by overload conditions.

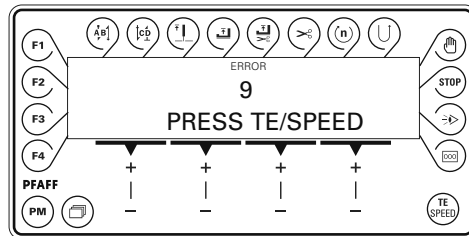

- Correct the error.



- Acknowledge error correction by pressing the TE/Speed key.

6 Parameter Settings

Group	Parameter	Description	Access level	Adjustment range	Standard value	
2	252	Puller roller clearance for start backtack ca. 4 mm	B, C	5 - 200	30	
	254	Puller roller clearance after trimming ca. 7mm	B, C	10 - 255	50	
3	302	Holding power of puller roller when rising	B, C	50 - 200	140	
	318	Puller lifts with automatic presser foot lift and starts with a delay depending on parameter 445. 1 = on, 0 = off.	B, C	0 - 99	1	
4	445	No. of stitches before puller roller touches down after machine start (Only when 318 is set at "1")	B, C	0 - 99	0	
	499	Stitches for puller delay after knee switch	A, B, C	0 - 99	0	
6	607	Maximum speed	B, C	300 - 6000	▲	
	660	Bobbin thread monitoring 0 = Off 1 = by sensor (-926/06) 2 = by stitch counting	A, B, C	0 - 2	0	
7	700	Needle position 0 (needle reference position)	B, C	0 - 255	*	
	702	Needle position 1 (needle lowered)	B, C	0 - 255	1181, 1183, 3701	90
		5483			100	
	703	Needle position 2 (take-up lever raised)	B, C	0 - 255	1181, 1183, 3701	236
		5483			208	
	760	Multiplier for the fixed value (200) for stitch count	A, B, C	0 - 250	5	
799	Selected machine class	C	1 - 3	1181, 3701	1	
	1183			2		
	5483			3		
8	800	Rotating direction of the motor	C	0 - 1	1181, 1183, 3701	0
		5483			1	

Parameter Settings

Group	Parameter	Description	Access level	Adjustment range	Standard value
9	985	Switch on angle for thread trapper	B, C	0 -255	67
	986	Switch off angle for thread trapper	B, C	0 -255	206
	989	Thread trapper at beginning of seam 1 = yes, 0 = no	B, C	0 - 2	0
10	1001	Stepping motor starting angle	B, C	0 - 255	1181, 3701
		1183			170
		5483			144
	1003	Feed roller radius	C	5 - 50	15
11	1100	Operating mode stepping motor 1	C	0 - 2	1
	1101	Rotation direction stepping motor 1 1 = anti-clockwise, 0 = clockwise	C	0 - 1	0
	1102	Stepping mode stepping motor 1 1 = full-step, 2 = half-step, 3 = quarter step, 4 = eighth step	C	0 - 4	3
	1103	Maximum current stepping motor in %	C	0 - 100	50
	1104	Reducing current stepping motor in %	C	0 - 50	30
	1105	Stepping motor 1, start-stop-time (time for 1 st step at start-stop-speed)	C	10 - 4000	180
	1106	Maximum speed stepping motor 1	C	10 - 4000	843
	1107	Acceleration in % of max. speed on stepping motor 1	C	1 - 50	28
	1108	Number of brake steps of stepping motor 1	C	1 - 50	5
1160	Feed motion compensation at beginning of seam	A, B, C	0 - 99	20	

▲ See Chapter 3 Specifications in the machine Instruction Manual.

* Adjustment see Chapter 3.01 Basic position of the machine drive unit.



The standard values listed in the table are basic settings, which can be altered if necessary.

Further parameters are contained in the Motor Instruction Manual

Internet update of the machine software

The machine software can be updated with PFAFF flash programming. For this purpose the PFP boot program and the appropriate control software for the machine type must be installed on a PC. To transfer the data to the machine, the PC and the machine control unit must be connected with an appropriate null modem cable (part no. 91-291 998-91).



The PFP boot program and the control software of the machine type can be downloaded from the PFAFF-homepage using the following path:
www.pfaff-industrial.com/pfaff/de/service/downloads

To update the machine software carry out the following steps:



While the machine software is being updated, no setting up, maintenance or adjustment work may be carried out on the machine!

- Switch off the machine.
- Connect the PC (serial interface or appropriate USB-adapter) and the machine control unit (RS232).
- Switch on the PC and start the PFP boot program.
- Select the machine type.
- Press the „programming“ button.
- An auxiliary program (Quickloader) is started.
- Switch on the machine within 60 seconds.
- The software update is carried out, the updating status is shown on the bar display.
- After the update has been completed, the message "**Software updated successfully completed**" appears.



If this message does not appear, the entire procedure must be repeated!
The operational reliability of the machine is not restored until the programming has been carried out successfully and without errors.

- Switch off the machine, end the quickloader and PFP-boot program.
- End the connection between the PC and the machine control unit.
- Switch on the machine.
A plausibility control is carried out and, if necessary, a cold start.



More information and assistance is at your disposal in the file „PFPHILFE.TXT“, which can be called up from the PFP boot program by pressing the „help“ button.

8 Reset / Cold start

After selecting the reset menu, by pressing the corresponding key it is possible to delete seam parameters, to delete seam programs or to carry out a cold start.

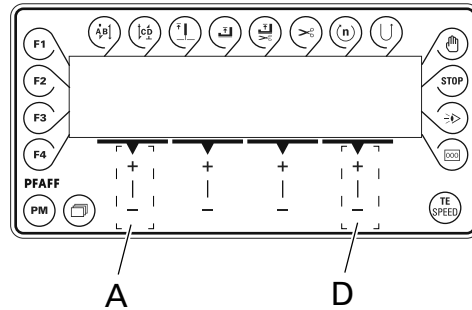

- Press and hold "+" on keys **A** and **D** and switch on the machine.

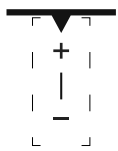
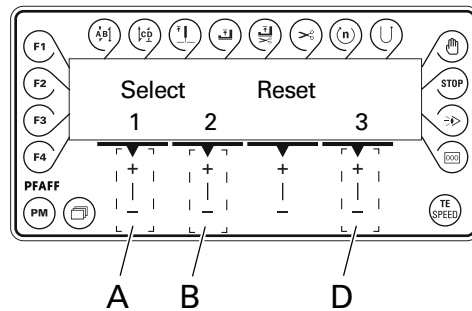

1 = Resetting the seam parameters

- Press "+" on key **A**.

All seam parameters are deleted, "MASTER-RESET 1" is displayed for a short time on the screen.

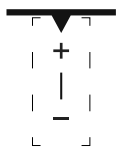

2 = Resetting the seam programs

- Press "+" on key **B**.

All seam programs are deleted, "MASTER-RESET 2" is displayed for a short time on the screen.

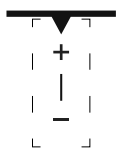

3 = Cold start

- Press "+" on key **D**.

The values of the machine control unit are set back to their basic values, except the value for the machine class. "COLD START" is displayed for a short time on the screen.



After a cold start, all programmed values are reset to their state at the time of delivery. For this reason, after a cold start, the parameters **799**, **800** and **700** must be checked and reset if necessary.

9 Partslist



Item No	Part No.	Item No	Part No.
1 - 15	95-774 673-71/895	9	91-262 860-92
1	91-262 916-91	10	91-262 865-92 (2x)
2	91-262 983-75/699	11	16-409 981-05
3 - 4	91-262 920-91	12	95-774 686-91
3	91-262 921-05	13	71-120 006-33
4	11-330 277-15 (2x)	14	95-784 321-91
5	91-262 919-05 (2x)	15	95-774 630-05 (10 mm wide)
6	71-520 000-70	16	91-292 276-91
7	11-130 179-15 (4x)		
8	95-774 647-05		

10 Circuit diagrams

10.01 Reference lists for the circuit diagrams of the 1180 and 3701 series (Connection diagram 91-191 504-95)

A1	Controller Quick P350 ED
A2	S2 control panel
A14	Sewing head recognition unit (OTE)
H1	Sewing lamp
H10	LED Stitch counter
M1	Sewing motor
M2	Linear motor lift puller
M3	Stepping motor roller presser
Q1	Main switch
S1	Pedal set value transmitter
S3	Puller release
S6	Start inhibitor E6 (stop)
S41	Manual backtacking key
S42	Needle position change key (threading key)
S43	Single stitch switch
S60	Edge guide key (optional)
X0	PC-interface (RS 232)
X1	Motor
X2	Incremental transmitter
X3	Speed control unit
X4/A	M3 stepping motor puller roller
X5	Outputs-Inputs
X6	Bobbin thread monitor (optional)
X7	Light barrier (optional)
X8	M2 linear motor lift puller
X13	S3 puller release
X16	S6 start inhibitor E6 (stop)
X23	Y23-900/.. Thread trimmer
X24	Y24-910/.. Automatic foot lift
X25	Y25-911/.. Backtacking/condensed stitches
X40	Keyboard S41-S43 + H11
X50	A14 sewing head recognition unit (OTE)
X60	S60 + Y60 Edge guide (optional)
Y2	-900/..Thread trimmer
Y4	-910/..Automatic presser foot lift
Y5	-911/Backtacking / condensed stitches
Y60	Edge guide (optional)

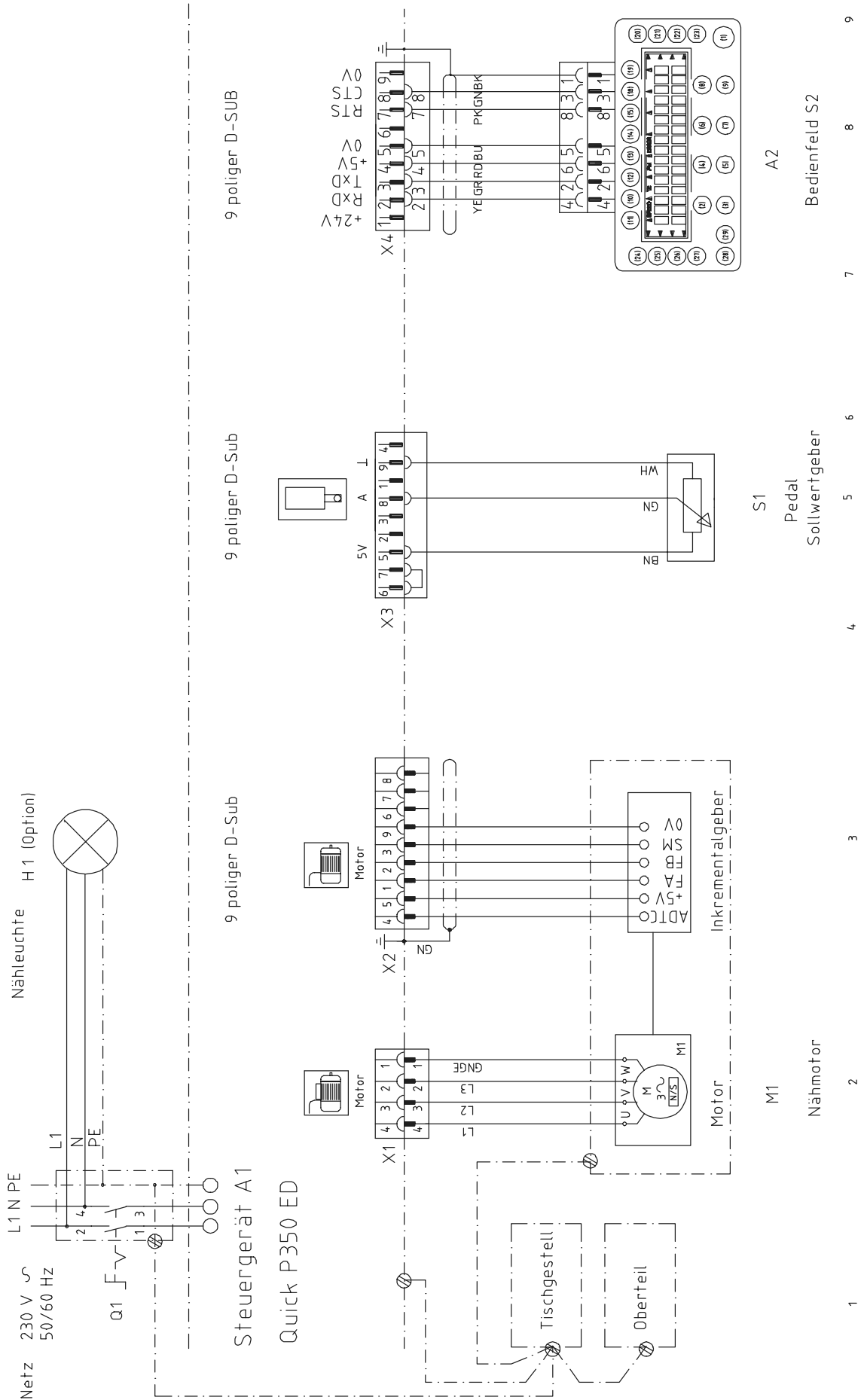

Steuergerät A1
Quick P350 ED

Ausgänge und Eingänge
37 poliger D-Sub

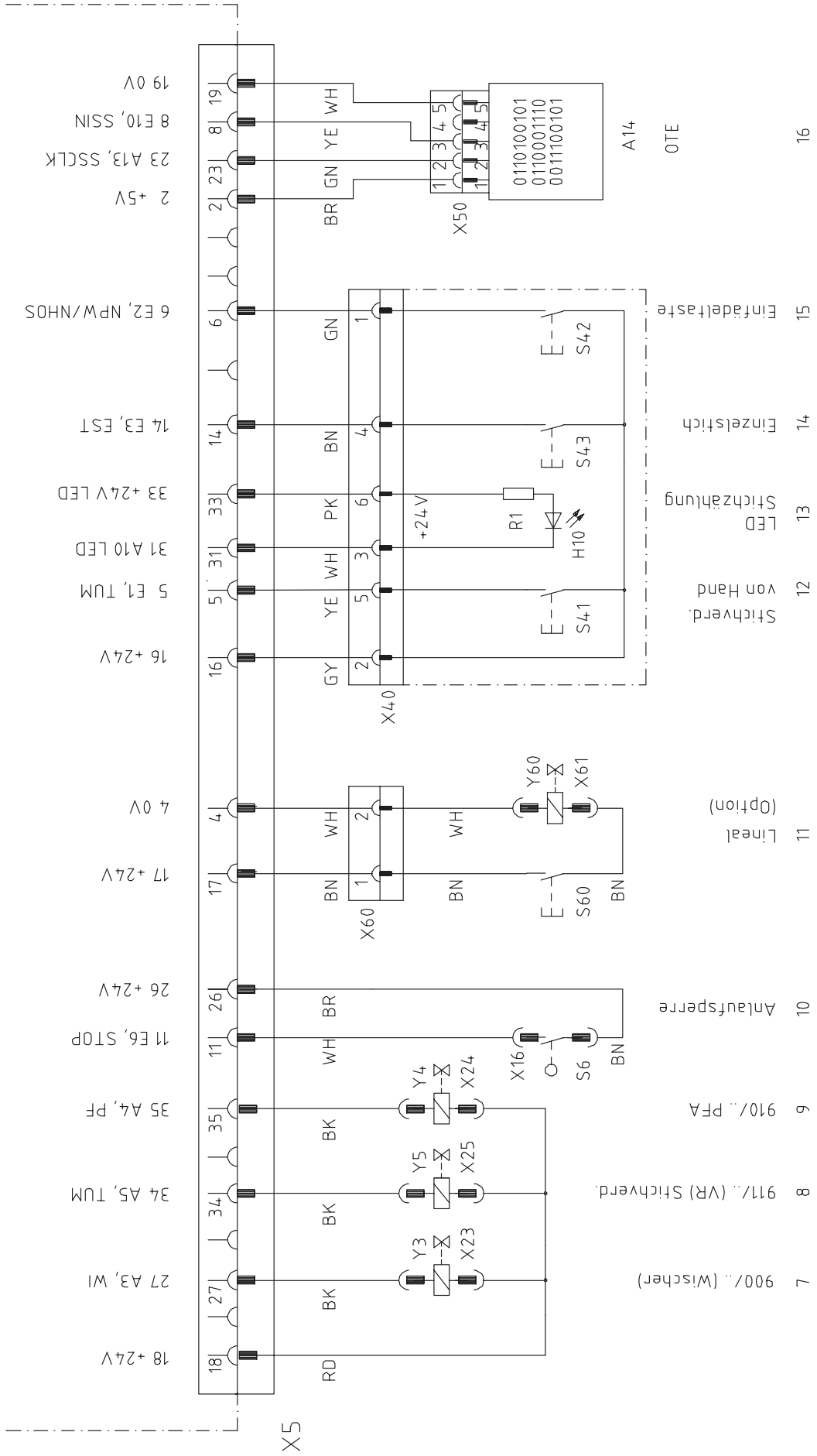

Steuergerät A1 Quick P350 ED

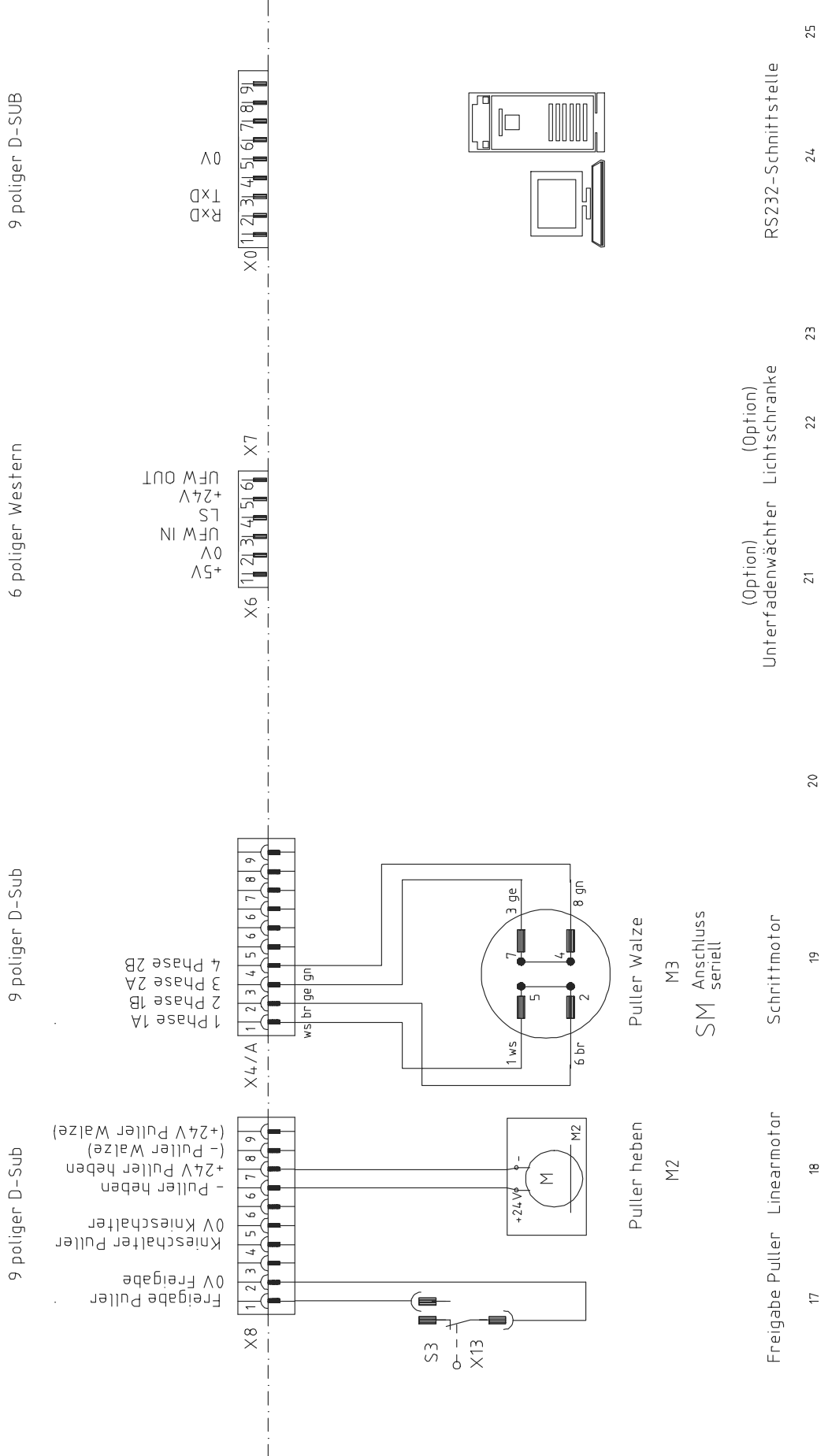

10.02 Reference lists for the circuit diagrams of the 5483
(Connection diagram 91-191 504-95)

A1	Controller Quick P350 ED
A2	Control panel BDF S2
A14	Sewing head recognition unit (OTE)
H1	Sewing lamp
H10	LED Stitch counter
M1	Sewing motor
M2	Linear motor lift puller
M3	Stepping motor roller presser
Q1	Main switch
S1	Pedal set value transmitter
S3	Puller release
S41	Manual backtacking key
S42	Needle position change key (threading key)
S43	Single stitch switch
S60	Edge guide key (optional)
X0	PC-interface (RS 232)
X1	Motor
X2	Incremental transmitter
X2.1	Inkrementalgeber Adapter
X2.2	Synchronisator Adapter
X3	Speed control unit
X4	A2 control panel BDF S2
X4/A	M3 stepping motor puller roller
X5	Outputs-Inputs
X6	Bobbin thread monitor (optional)
X7	Light barrier (optional)
X8	M2 linear motor lift puller
X13	S3 puller release
X23	Y23-900/.. Thread trimmer
X24	Y24-910/.. Automatic foot lift
X25	Y25-911/.. Backtacking/condensed stitches
X40	Keyboard S41-S43 + H11
X50	A14 sewing head recognition unit (OTE)
X60	S60 + Y60 Edge guide (optional)
Y2	-900/..Thread trimmer
Y4	-910/..Automatic presser foot lift
Y5	-911/Backtacking / condensed stitches
Y60	Edge guide (optional)

Steuergerät A1
Quick P350 ED

Ausgänge und Eingänge
37 poliger D-Sub

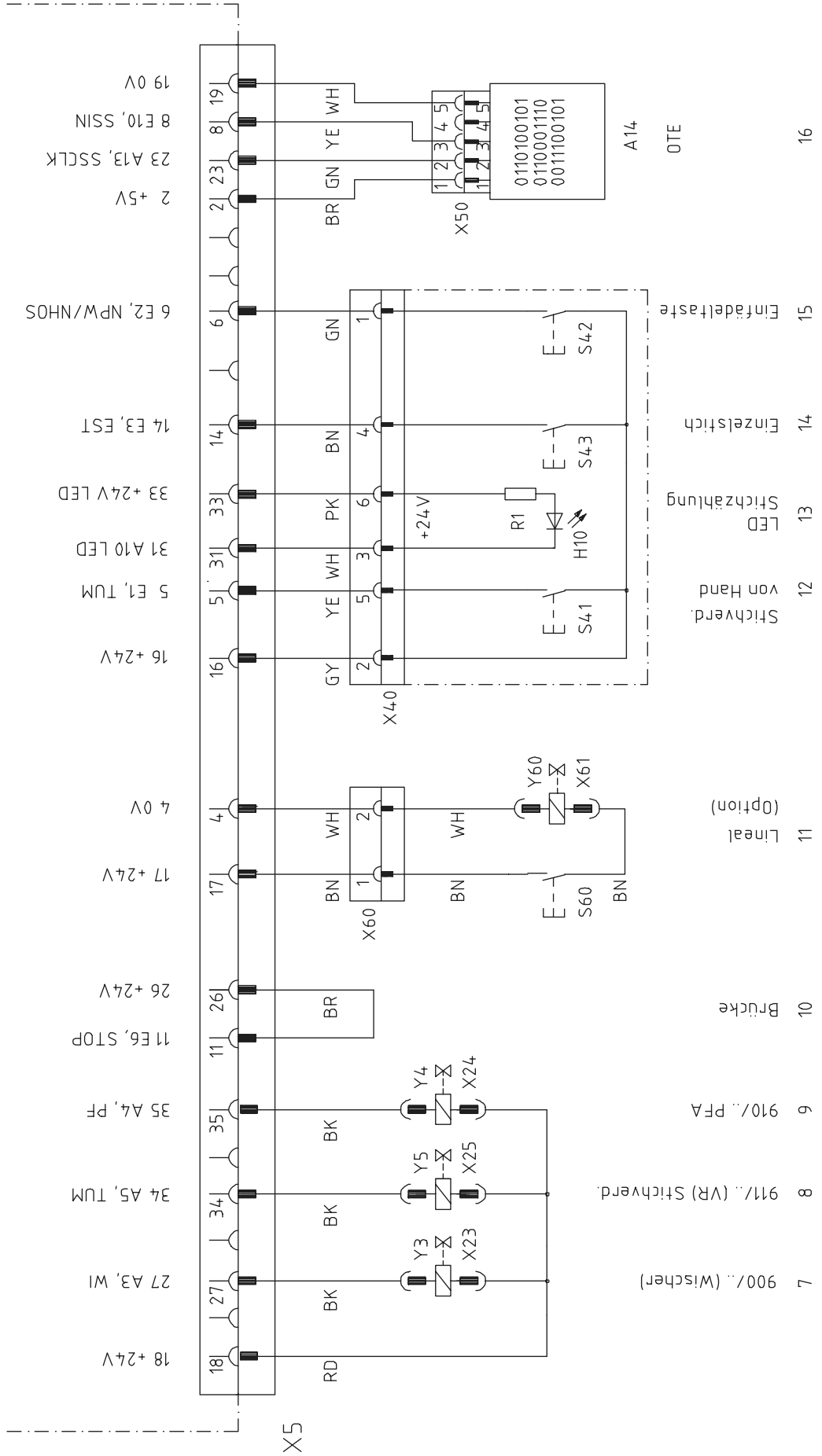

Steuergerät A1 Quick P350 ED

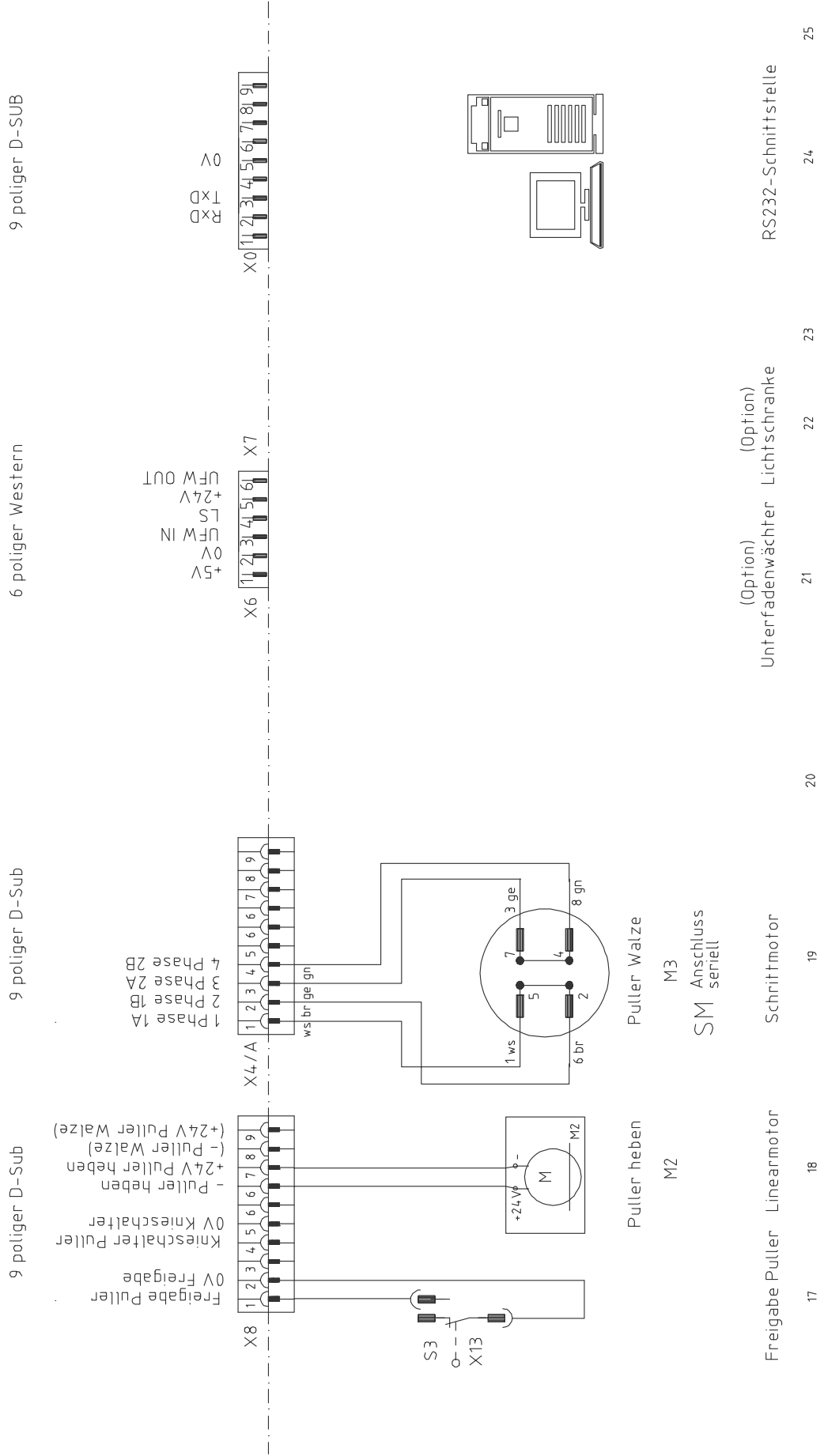



Europäische Union
Wachstum durch Innovation – EFRE



PFAFF Industriesysteme und Maschinen AG

Hans-Geiger-Str. 12 - IG Nord
D-67661 Kaiserslautern

Phone: +49-6301 3205 - 0
Fax: +49-6301 3205 1386
E-mail: info@pfaff-industrial.com

Hotlines:

Technical service: +49-175/2243-101
Application consultancy: +49-175/2243-102
Spare-parts hotline: +49-175/2243-103

Printed in Germany