

## **-918/55**

Supplement to the instruction  
and adjustment manual for the  
PFAFF **487, 489** and **5487**

The reprinting, copying or translation of PFAFF Instruction Manuals, whether in whole or in part, is only permitted with our previous authorization and with written reference to the source.

**PFAFF Industriesysteme  
und Maschinen AG**

Hans-Geiger-Str. 12 - IG Nord  
D-67661 Kaiserslautern

---

	Contents .....	Page
<b>1</b>	<b>Proper use.....</b>	<b>5</b>
<b>2</b>	<b>Controls .....</b>	<b>6</b>
2.01	Knee Switch .....	6
2.02	Control panel.....	6
2.03	Keyboard .....	7
<b>3</b>	<b>Installation and commissioning .....</b>	<b>9</b>
3.01	Connecting the plug-in connections and earth cables .....	9
3.02	Basic position of the machine drive unit .....	10
3.02.01	With control unit P320 ED .....	10
3.02.02	With control unit P323 MS .....	12
<b>4</b>	<b>Preparation .....</b>	<b>13</b>
4.01	Selecting the program number .....	13
4.02	Inputting fullness .....	14
4.03	Entering / altering the code number .....	15
4.04	Adjusting the control panel .....	17
<b>5</b>	<b>Sewing .....</b>	<b>18</b>
5.01	Manual sewing.....	18
5.01.01	Entering the seam start and seam end in manual sewing mode .....	20
5.02	Sewing with fixed programs .....	21
5.03	Programmed sewing.....	23
5.03.01	Program interruption .....	25
5.04	Error messages.....	25
<b>6</b>	<b>Input .....</b>	<b>26</b>
6.01	Seam program input .....	27
6.01.01	Basic settings for seam program input .....	27
6.01.02	Seam program input with the "Creating/adjusting a program" functionen" .....	29
6.01.03	Seam program input with the "Creating/adjusting a program" function .....	31
6.01.04	Entering the functions at the beginning of the seam during seam programming .....	33
6.01.05	Entering the functions at the end of seam section during seam programming.....	34
6.02	Examples of how to create a seam program .....	36
6.02.01	Example of a seam program input with the "creating/adjusting a program" function .....	36
6.02.02	Example of a seam program input using the "teach-in" function.....	39
6.03	Seam program administration.....	41
<b>7</b>	<b>Adjustment differing from the basic machine .....</b>	<b>43</b>
7.01	Basic setting of the differential adjustment device .....	43
7.02	Parameter settings.....	44
7.02.01	Overview of the parameter functions .....	44
7.02.02	Example of a parameter input.....	45
7.03	List of parameters.....	46

---

	Contents .....	Page
7.04	Sewing motor errors .....	48
7.05	Explanation of the error messages .....	49
7.06	Table of inputs.....	50
7.07	Table of outputs .....	50
7.08	Service menu.....	51
7.09	Carry out a cold start .....	52
7.10	Internet update of the machine software .....	53
<b>8</b>	<b>Circuit diagrams .....</b>	<b>54</b>

1      **Proper use**

The PFAFF 487-918/55, 489-918/55 and the PFAFF 5487-918/55 are single-needle, ultra-high-speed sewing machines with programmable fullness control.

The PFAFF 487-918/55 and the 489-918/55 are used to sew lockstitch seams in industry.

The PFAFF 5487-918/55 is used to sew two-thread chain stitch seams in industry.



Any and all uses of this machine which have not been approved of by the manufacturer are considered to be inappropriate! The manufacturer cannot be held liable for any damage caused by the inappropriate use of the machine! The appropriate use of the machine includes the observance of all operational, adjustment, maintenance and repair measures required by the manufacturer!

## 2 Controls

### 2.01 Knee Switch

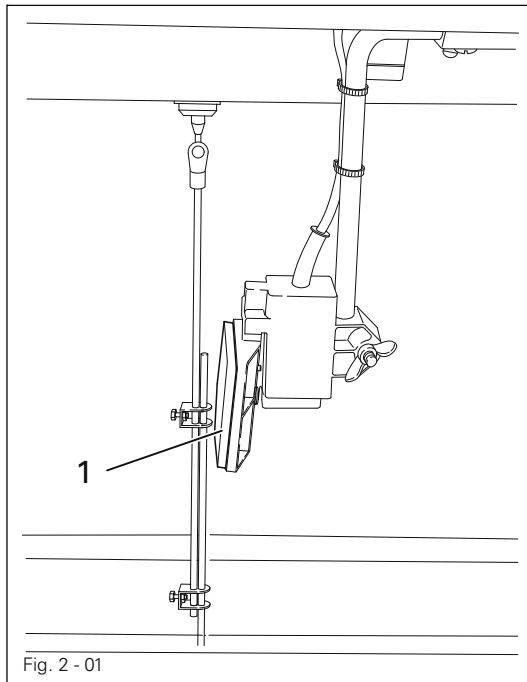

#### Manual sewing:

- By operating knee switch 1 it is possible to alternate between two pre-set amounts of fullness.

#### Programmed sewing:

- By operating knee switch 1 the amounts of fullness are changed according to the program selected.

### 2.02 Control panel

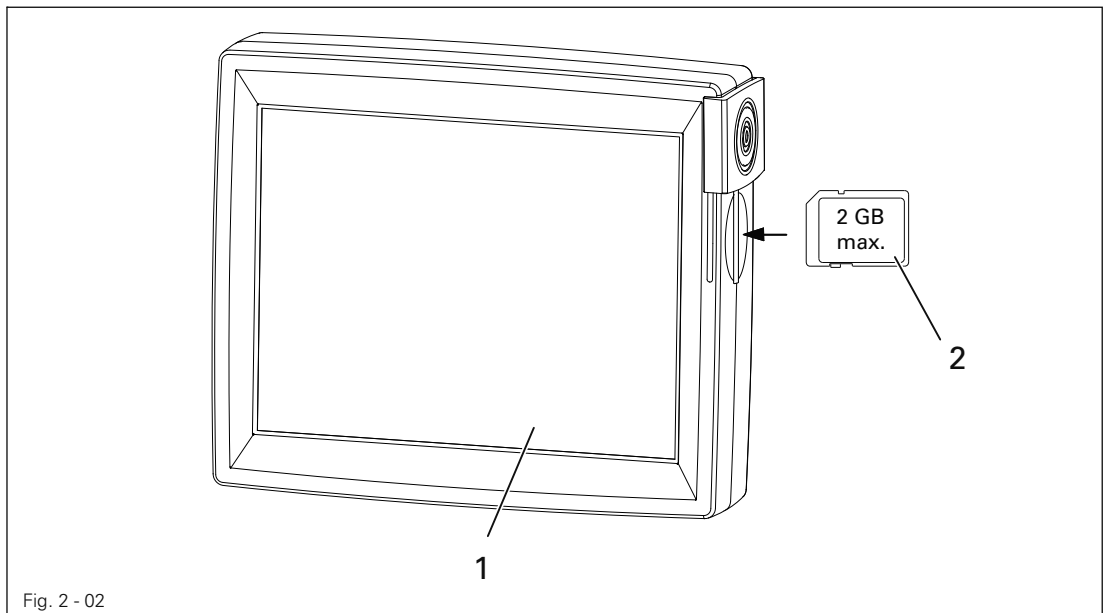

The current operating conditions are displayed on control panel 1. Operation takes place in a constant dialogue between the control unit and the operator. For this purpose, depending on the operating condition of the machine, different symbols and/or texts are displayed. If the symbols or texts are framed, these show functions which can be selected by pressing the appropriate position on the monitor. By pressing the corresponding function this is carried out or switched on or off immediately, or a further menu appears, e.g. for entering a value.

Activated functions are shown with inverted symbols. Unframed symbols or texts are only used for display purposes and cannot be selected by pressing.

To read sewing programs or install machine software, use the sd-card 2 in the control panel.

## Description of the functions

 Normal symbol = function switched off (inactive)

 Inverted symbol = function switched on (active)

## 2.03 Keyboard

The keyboard is used for the quick operation of the machine during sewing and when selecting the fullness. With the corresponding LED of the 20 keys, active key functions are displayed (Function active = LED lit).

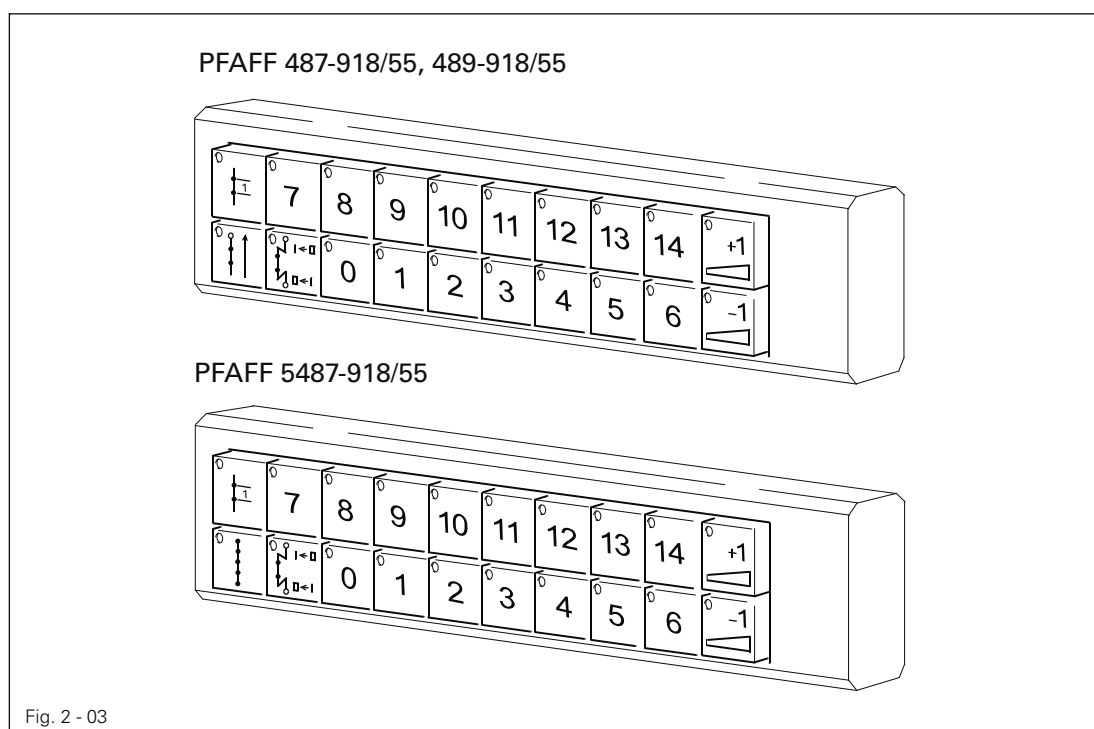

Fig. 2 - 03



### Single stitch

- If the single stitch key is pressed, the machine sews a single stitch.



### Stitch condensation (only on the PFAFF 5487)

- The stitch condensation is switched on and off by pressing a key.  
(When programming the seam: Sew the seam section with condensed stitches)



## Reverse sewing direction (only on the PFAFF 487), 489

- As long as the reverse sewing key is pressed, the machine sews in reverse. For the programming and learning functions, the relevant seam section is programmed "in reverse".



## Bartack suppression

- If the bartack function is activated, by pressing this key once the next bartack and by pressing it twice the next two bartacks are not sewn.



## Correction value + / correction value -

- If this key is pressed, the fullness value is increased or reduced in 2 steps. Fullness value 0 is not corrected. To make this possible, a correction value different to 0 must be entered in parameter 209.

## Number keys 0 - 14

- The previously allocated amount of fullness is called up by pressing a key. When two neighbouring number keys are pressed simultaneously, the corresponding average value is selected.
- In the manual sewing mode, the fullness can be allocated to the individual keys. The current fullness value (which can be set on the touch-screen) is allocated to a key if it is pressed for a long time (>3s). A bleep signalizes that the value has been saved. Following values are pre-set and can be altered as described above.

Key 0: No fullness will be applied.

Key 14: Maximum fullness is selected.



The fullness values are designed for a basic stitch length of 2.5 mm. When sewing with shorter stitch lengths, the gathering intensity is increased, with longer stitch lengths it is reduced accordingly.



## 3 Installation and commissioning



The machine must only be mounted and commissioned by qualified personnel!  
All relevant safety regulations are to be observed!

### 3.01 Connecting the plug-in connections and earth cables

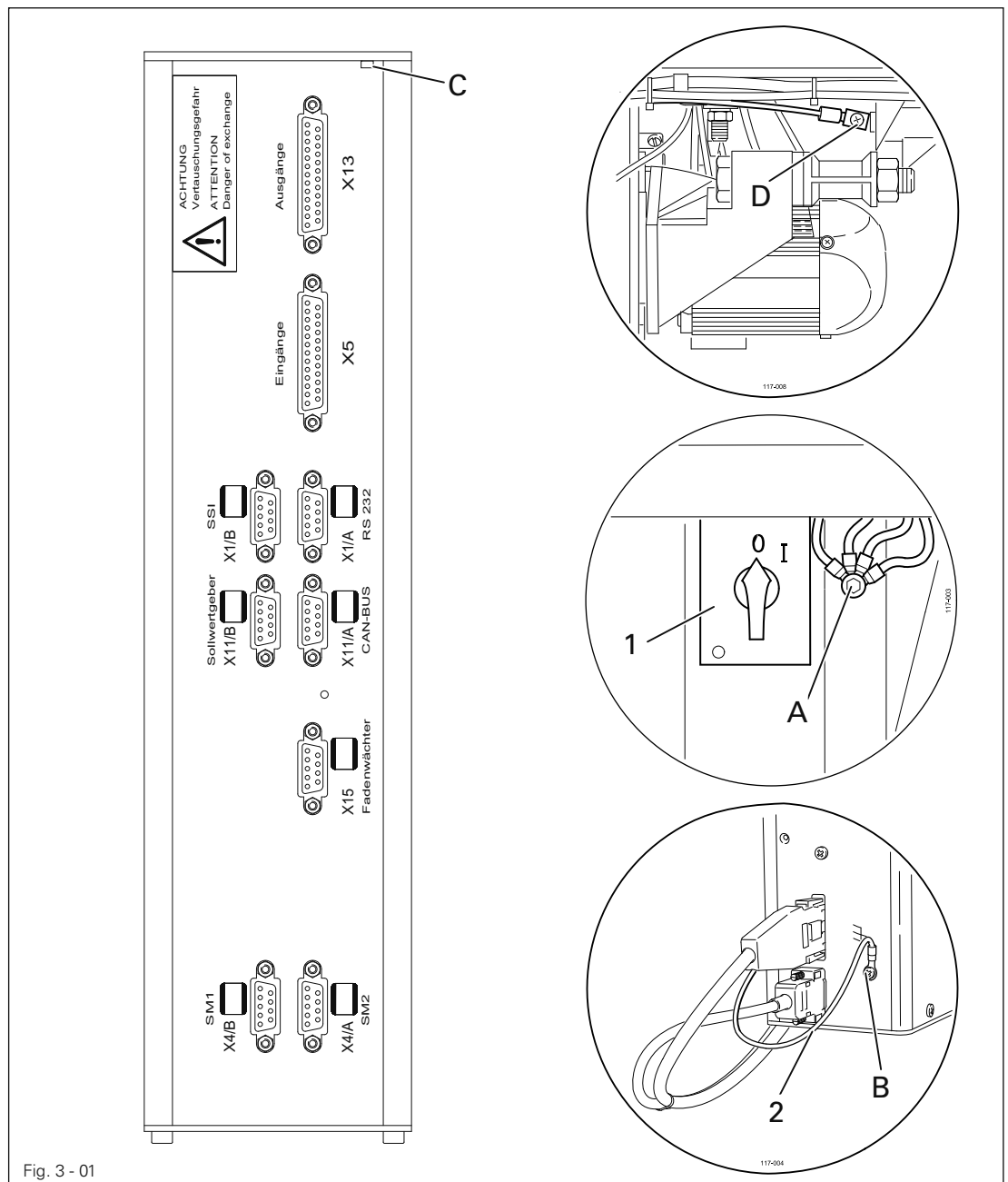

- Connect all plugs as labelled to the control box .
- Screw the earth cable from the sewing head to earth point **A**.
- With an earth cable connect earth point **C** and **D** to earth point **A**.
- Screw the earth cable from the main switch **1** to earth point **A**.
- Screw the earth cable **2** from the motor to earth point **B**.

# Installation and commissioning

## 3.02 Basic position of the machine drive unit

### 3.02.01 With control unit P320 ED

- Switch on the machine.



- Call up the input mode.

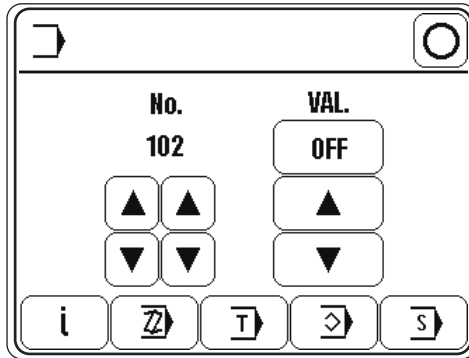

- Call up the service function.

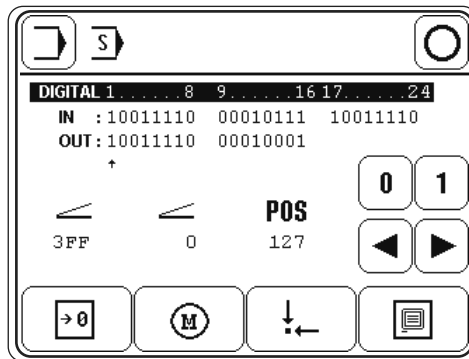

- Call up the motor service function.

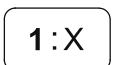
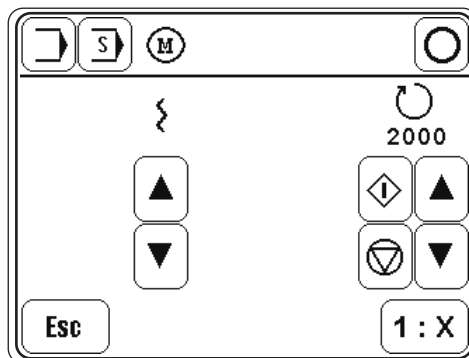

- Press this key for the machine to learn the transmission ratio.



#### Attention!

After this key has been operated, the machine sews 3 stitches at a speed of approx. 360 rpm.

- Call up the input mode.

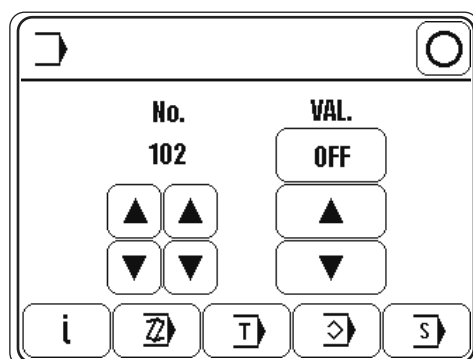

- Call up parameter "301".

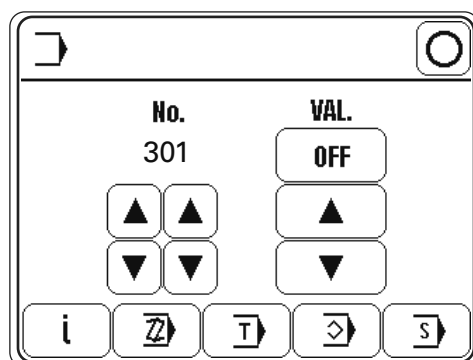

- Turn the balance wheel in the direction of rotation until the needle point, descending from above, is flush with the top edge of the needle plate.

- Conclude the input.
- Switch off the machine.

# Installation and commissioning

## 3.02.02 With control unit P323 MS

- Switch on the machine.
- Call up the input mode.

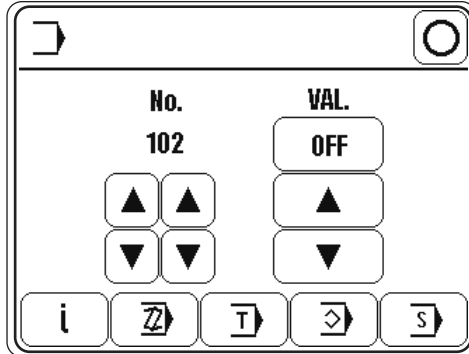

- Call up the service function.

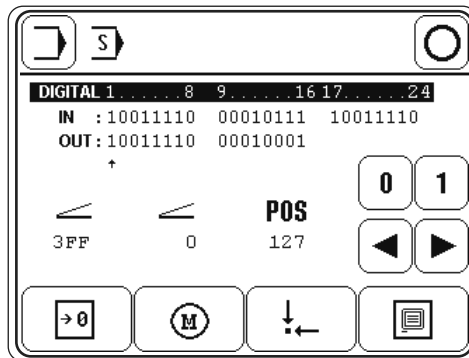

- By turning the balance wheel in the sewing direction, ascertain the number of increments per turn (this maximum value appears under "POS" in the display before the reading jumps back to "0").



- Call up the input mode.



- Call up parameter "721".

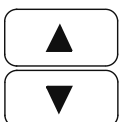
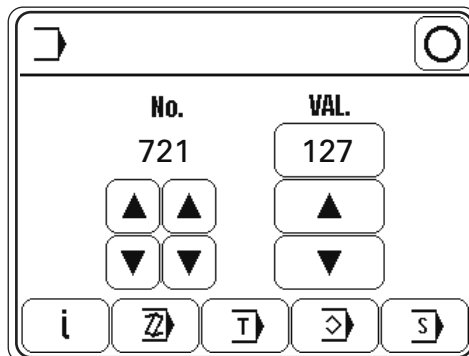

- Enter the calculated max. value.



- Conclude the input.
- Switch off the machine.

## 4 Preparation



All regulations and instructions in this Instruction Manual are to be observed!  
Special attention is to be paid to the safety regulations!

All preparation work is only to be carried out by appropriately trained personnel.

## 4.01 Selecting the program number

- Switch on the machine.

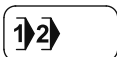

- Call up the program number input menu.

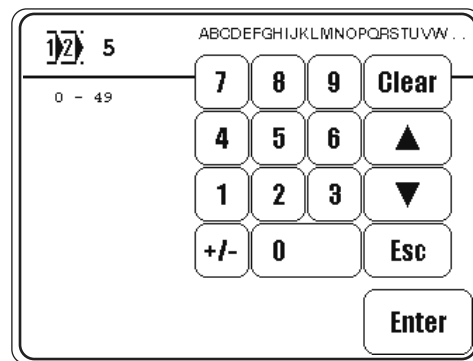

- Select the desired program number.



- Confirm the selection and quit the selection menu.



The sewing method is determined by the program number selected, see Chapter 5 Sewing.

Program number 0:	Manual sewing
Program number 1 and 2:	Sewing with fixed programs
Program number 3 to 49:	Programmed sewing

# Preparation

## 4.02 Inputting fullness

- Switch on the machine.



- Call up the program number input menu.



- Select program number "0"..



- Confirm the selection and quit the selection menu.

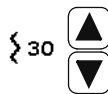
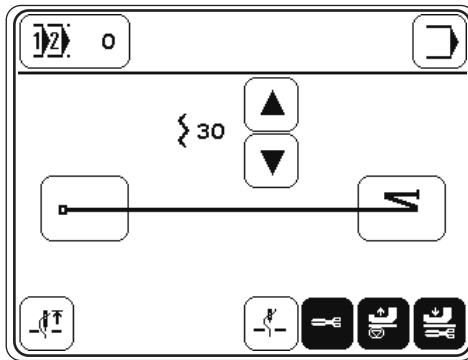

- Enter the desired value with the appropriate arrow keys.

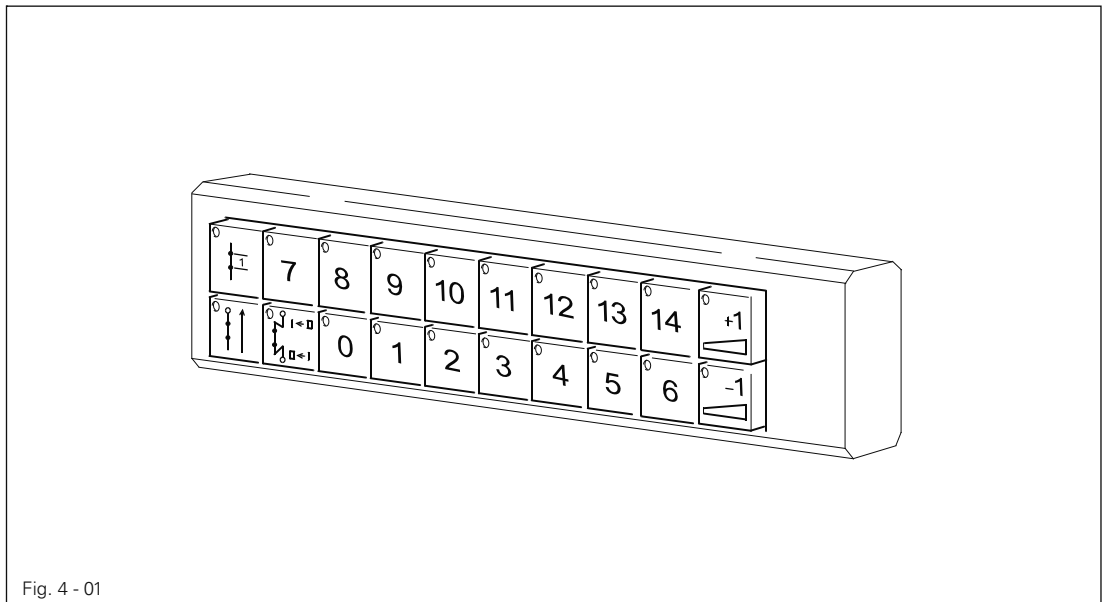

- If necessary, allocate the current fullness amount to one of the number keys (0-14) on the keyboard. To do so, press the required key until a beep is heard.

## 4.03 Entering / altering the code number

- Switch on the machine.



- Call up the input mode.

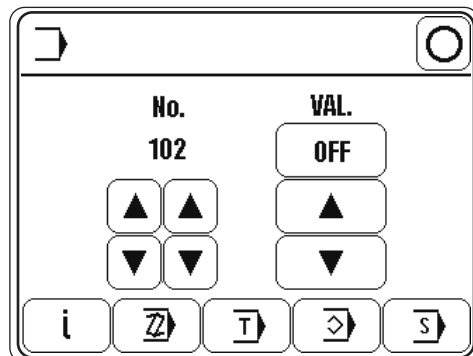

- Select parameter "800".

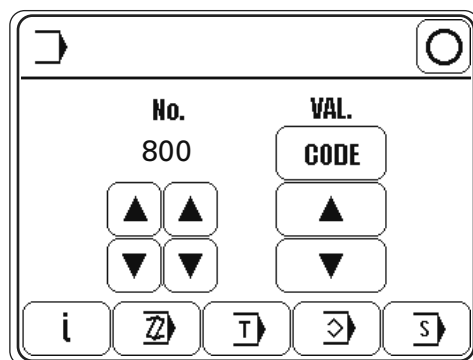

**CODE**

- Select the code number input menu.
- Enter the code number on the number keys (factory code setting is "3800").

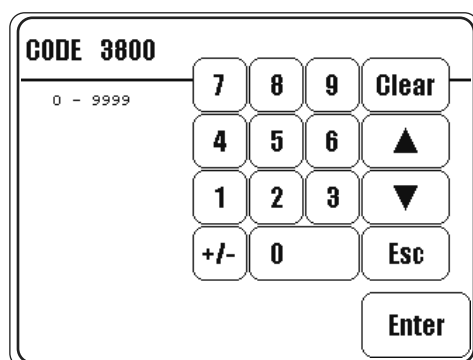

Enter

- Take over the code number entered.

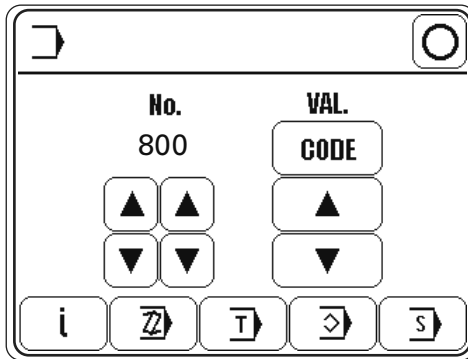

The code input remains stored until the machine is switched off at the main switch. As long as the machine is not switched off, all parameters are freely accessible without having to enter the code number again.



- Select parameter "810"

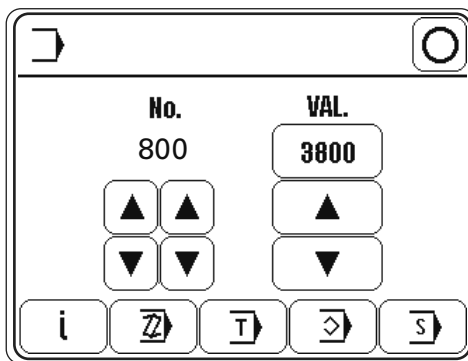

0487

- Call up the code number input menu and enter the desired code number.

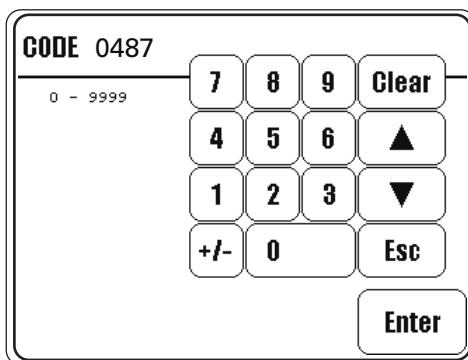

Enter

- Take over the new code number.



- Conclude input.



**Do not forget the code!**

Without the appropriate code, the protected functions cannot be called up! Help is then only possible through PFAFF service staff.



4.04 Adjusting the control panel

- Switch on the machine.
- Call up the input mode.

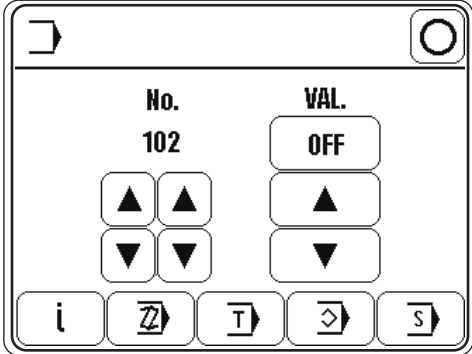

- Select the service menu.

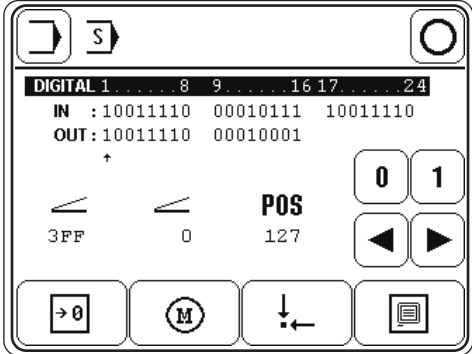

- Select control panel functions.

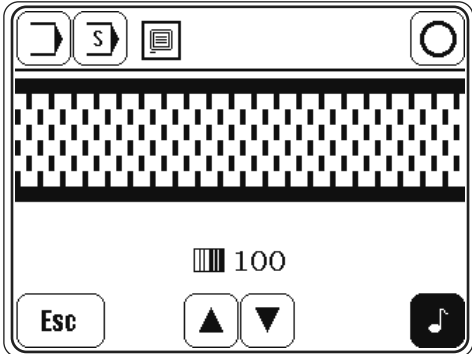

- Change the display contrast.



- Switch the key tone off or on.



Never reduce the display contrast to the extent, that the display can no longer be read!

## 5 Sewing

In the sewing mode all relevant settings for the sewing operation are displayed on the screen and can be altered with the corresponding functions.

In the sewing mode a difference is made between manual sewing, sewing with fixed programs and programmed sewing.

The selection is made with the corresponding program number:

- 0: Manual sewing
- 1 and 2: Sewing with fixed programs
- 3 to 49: Programmed sewing  
(with up to 15 seam sections for both the left and right seam)

### 5.01 Manual sewing

In the manual sewing mode the fullness values are displayed on the control panel and can be altered directly by using appropriate function, just as the functions at the beginning and the end of the seam and the needle and sewing foot positions.

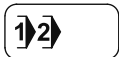

Switch on the machine and select program number "0", see Chapter 4.01 **Selecting the program number**.

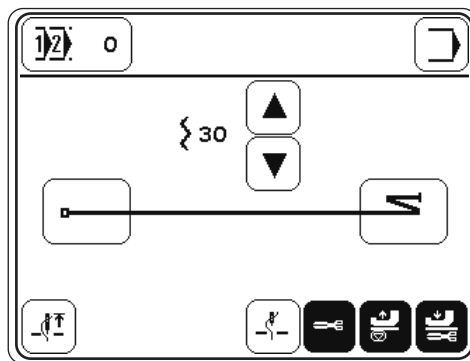

#### Explanation of the functions

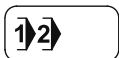

##### Program selection

This opens the menu for entering the program number, see Chapter 4.01 **Selecting the program number**.



##### Input mode

Exit the sewing mode and select the input mode.

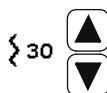

##### Fullness

Alters the value for fullness, see Chapter 4.02 **Inputting fullness**



##### Seam start

Opens the menu for entering the functions at the beginning of the seam, see Chapter 5.01.01 **Entering the seam start and seam end functions in the manual sewing mode**.



## Seam end

Opens the menu for entering the functions at the end of the seam, see Chapter 5.01.01 Entering the seam start and seam end functions in the manual sewing mode.



## Needle raised

Moves the needle to its highest position



## Needle position raised

When this function is activated, the needle moves to its highest position after sewing stops.



## Thread trimming

When the function is activated, enables thread trimming with the pedal function.



## Sewing foot raised

When this function is activated, the sewing foot is raised after sewing stops.



## Sewing foot lowered after thread trimming

When this function is activated, the sewing foot is not raised after thread trimming.

- Sewing is carried out with the pedal functions.

## 5.01.01 Entering the seam start and seam end in manual sewing mode



After the appropriate function has been selected, the menu for entering the value for condensed stitches or for backtacks appears.

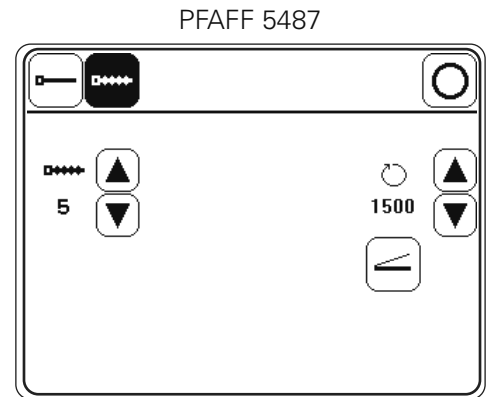
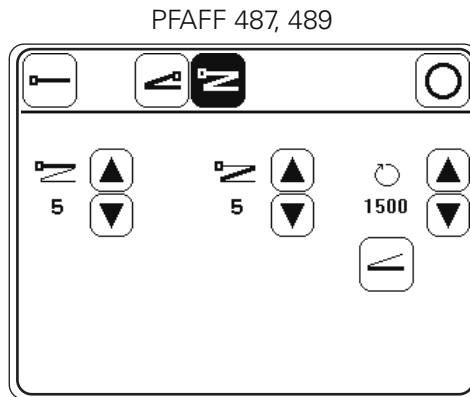

- **PFAFF 487, 489**



Switch on the single start backtick function and call up the menu for entering the values. (1 – 9 stitches can be entered).

or



- Switch on the double start backtick function and call up the menu for entering the values. (1 – 9 stitches can be entered).

- **PFAFF 5487**



Switch on the condensed stitches function and call up the menu for entering the values. (1 – 30 stitches can be entered).



- In each case change the number of stitches for the condensed stitches or the number of backtick stitches with the appropriate arrow keys.



- Change the value for the maximum speed during the condensed stitches or backtacking operation (100 – 1500 spm can be entered).



- Choose whether the condensed stitches or the backtacking operation at the beginning of the seam should be carried out at a fixed speed (normal symbol) or at a pedal-controlled speed (inverse symbol).



- Conclude the input.



- In the manual sewing mode, the functions for the seam end are entered in the same way as those for the seam start.

## 5.02 Sewing with fixed programs

Fixed programs are stored under the program numbers **1** and **2**.

The fixed programs are used for the quick and easy production of seams with different amounts of fullness. When sewing with fixed programs, **2** or **3** seam sections are sewn after each other. With the knee switch it is possible to move to the next section. The fixed programs are designed as cyclic running programs, i.e. at the end of the last seam section, the machine moves back to the first seam section. The fullness value can be selected for each seam section, the settings for needle and foot positions apply to all sections and can be altered at any time with the appropriate function.



The fullness values are designed for a basic stitch length of **2.5 mm**. When sewing with shorter stitch lengths, the gathering intensity is increased, with longer stitch lengths it is reduced accordingly.



- Switch on the machine and select program number "1" or "2", see Chapter 4.01 **Selecting the program number**.

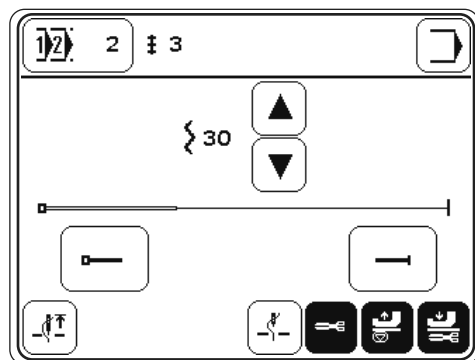

### Explanation of the displays and functions



#### Program selection

This opens the menu for entering the program number, see Chapter 4.01 **Selecting the program number**.



#### Seam section

Shows the number of seam sections in the sewing program.



#### Input mode

Exit the sewing mode and select the input mode.

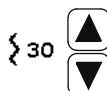

#### Fullness

Alters the fullness value, see Chapter 4.02 **Inputting fullness**.



#### Seam start

Opens the menu for entering the functions at the beginning of the seam, see Chapter 5.01.01 **Entering the seam start and seam end functions in the manual sewing mode**.



#### Seam end

Opens the menu for entering the functions at the end of the seam, see Chapter 5.01.01 **Entering the seam start and seam end functions in the manual sewing mode**.

**Needle raised**

Moves the needle to its highest position

**Needle position raised**

When this function is activated, the needle moves to its highest position after sewing stops.

**Thread trimming**

When the function is activated, enables thread trimming with the pedal function.

**Sewing foot raised**

When this function is activated, the sewing foot is raised after sewing stops.

**Sewing foot lowered after thread trimming**

When this function is activated, the sewing foot is not raised after thread trimming.

- Sewing is carried out with the pedal functions.

### 5.03 Programmed sewing

With the program numbers **3 - 49** it is possible to call up previously programmed seams. In programmed sewing all seam sections for pre-gathering a sleeve are set in one seam program. The information about the seam program, such as program number, number of programmed seam sections, programmed comments is displayed.

For better orientation a seam sketch is shown with the programmed seam sections. The seam start, seam end, the seam sections already sewn, the current seam section and the seam sections still to be sewn are illustrated by symbols and different types of lines with different thicknesses. For the current seam section the corresponding parameters for seam section number, fullness with fullness adjustment and the number of stitches (length of seam section) are displayed. To control the seam sequence, the current seam (left or right seam) and the automatic changeover from left to right seam can be switched over or switched on.



- Switch on the machine, select the desired program number from "3" to "49", see Chapter 4.01 **Selecting the program number**.

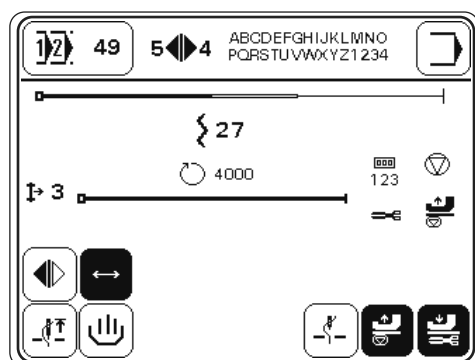

#### Explanation of the displays and functions



##### Program selection

This opens the menu for entering the program number, see Chapter 4.01 **Selecting the program number**.



##### Seam section right/left

Shows the number of seam sections in the seam program for the right/left sleeve seam.



##### Input mode

Exit the sewing mode and select the input mode.



##### Fullness

Shows the current fullness value.



##### Current seam section

Shows the current seam section.



## Current seam

This function is used to select and display the current seam (right/left).



## Automatic seam change

When this function is activated, the machine changes automatically from the right to left seam.



## Needle raised

Moves the needle to its highest position



## Program interruption

Interrupts the program sequence, see Chapter 5.03.01 Program interruption



## Thread trimming

When the function is activated, enables thread trimming with the pedal function.



## Sewing foot raised

When this function is activated, the sewing foot is raised after sewing stops.



## Sewing foot lowered after thread trimming

When this function is activated, the sewing foot is not raised after thread trimming.

- Sewing is carried out with the pedal functions.



## 5.03.01 Program interruption

- With the "program interruption" function the programmed seam sequence is interrupted (e.g. if the thread breaks).



- Interrupt program sequence.

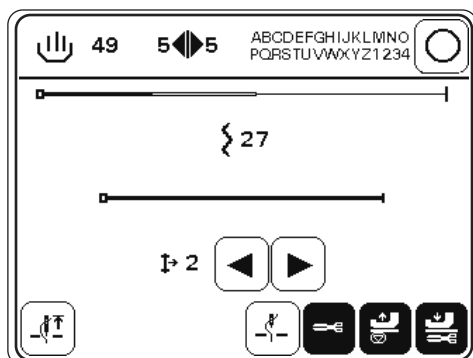

- If necessary, tact forwards or backwards through the sections of the seam program.

- If necessary, change the values and carry out the other functions as in manual sewing, see Chapter 10.01 Manual sewing.



- If necessary, call up programmed sewing again..

## 5.04 Error messages

If an error occurs, the text "ERROR" appears on the display, together with an error code. An error message is caused by incorrect settings, defective elements or seam programs and by overload conditions.

For an explanation of the error codes see Chapter 7.05 Explanation of the error messages.

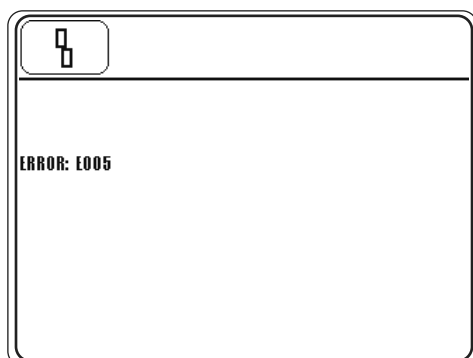

- Eliminate the error.



- Confirm error elimination.

## 6 Input

In the input mode the functions parameter input, information, creating/adjusting a sewing program, teach-in, program administration and service are available.

- Switch on the machine.



- Call up the input mode.

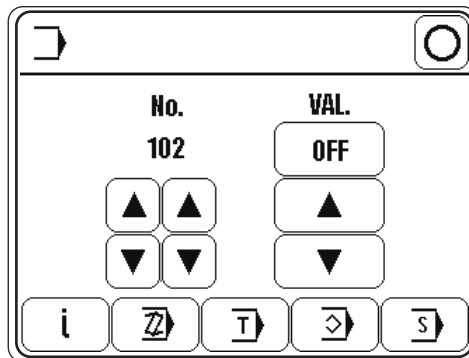

### Explanation of the functions



#### Sewing mode

Quit the input mode and call up the sewing mode.



#### Parameter selection

Select the hundred and unit figures of the desired parameters, see Chapter 7.02.02 Example of a parameter input.

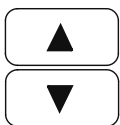

#### Altering the parameter value

Change the value of the selected parameter, see Chapter 7.02.02 Example of a parameter input.



#### Software information

Calls up information about the current machine software.



#### Creating/adjusting a program

Opens the menu for entering or altering a seam program, see Chapter 6.01.02 Seam program input with the "Creating/adjusting a program" function.



#### Teach In

Opens the menu for entering seam programs after sewing a sample, see Chapter 6.01.03 Seam program input with the "Teach in" function.



#### Program administration

Opens the menu for seam program administration, see Chapter 6.03 Seam program administration.



#### Service

Opens the service menu, see Chapter 7.08 Service menu.

## 6.01 Seam program input

Seam programs can be created by entering parameters in the "Creating/adjusting a seam program" function, or by sewing a sample with the "Teach in" function. Irrespective of which function is being used, first of all it is necessary to select the program number and the basic settings of the seam program, which is to be sewn.

### 6.01.01 Basic settings for seam program input

The basic settings in the "creating/adjusting a program" and the "teach-in" functions are the same.

- Switch on the machine.



- Call up the input mode.



- Call up the "Creating/adjusting a seam program" or the "Teach in" function.

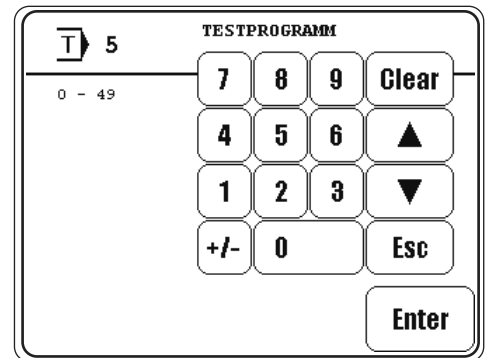
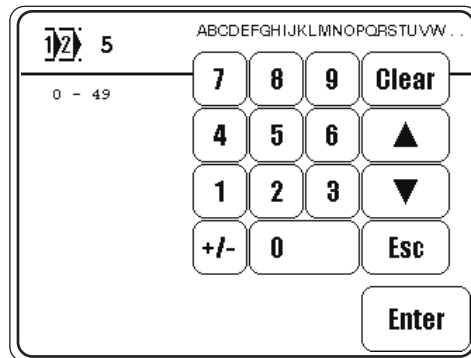

- If necessary, change the selected program number and confirm the selection.



- If applicable, enter or change a comment.



- Set the seam type (by pressing the appropriate symbol several times until the appropriate seam type is displayed).

Description of the symbols:



Sewing program with left and right seam, beginning with the right seam.



Sewing program with left seam only.



Sewing program with right seam only.



Sewing program with left and right seam, beginning with the left seam.

**Enter**

- Conclude the input of the basic settings and change to the seam section input, see Chapter 6.01.02 **Seam program input with the "Creating/adjusting a program" function** or Chapter 6.01.03 **Seam program input with the "Teach in" function**.



The input can also be concluded by calling up the sewing mode. In this case the seam program input is concluded and the machine changes to programmed sewing.

6.01.02 Seam program input with the "Creating/adjusting a program" functionen"

With this function the seam program is entered by entering or changing the appropriate values on the control panel. This type of seam program input is particularly suitable for adjusting existing seam programs.

- Switch on the machine.



- Call up the input mode.



- Call up the "creating/adjusting a program" function.



- Carry out the basic settings and conclude with the "Enter" function, see Chapter 6.01.01 Basic settings for seam program input.

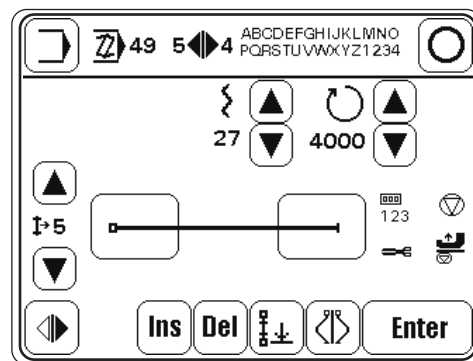

- Alter the fullness, see Chapter 4.02 Inputting fullness.



- Alter the maximum speed for the current seam section.



- These functions are used to scroll through the current seam program. The current seam section is displayed accordingly, in addition to all the other current values.



- Enter the seam start functions, see Chapter 6.01.04 Entering the functions at the beginning of the seam during seam programming.



- Enter the functions for the end of the seam section, see Chapter 6.01.05 Entering the end of the seam section when programming the seam.



- Select a seam type  
It is only possible to select the right or left seam, if the seam type "right and left seam" was selected in the basic setting, see Chapter 6.01.01 Basic settings for seam program input.

---

## Input

---



- If necessary, insert the seam section.  
The current seam section is copied and all following seam sections are set one place back.



- If necessary, delete the current seam section.



- If necessary, conclude the input of the current seam and store the parameter for the other seam in the reverse order (mirror seam).



- Set the seam end or program end.  
If entering only one seam (only the right or only the left seam) the program end is set in the desired seam section.  
In the same way as the program end, the seam end is set when entering the right and left seam. The seam end is set in the first seam and the program end in the second seam.

**Enter**

- Conclude the input of the first seam section and change to the next seam section.





- Conclude the input and change to the input of the basic settings.



- Conclude the input and change to programmed sewing.



6.01.03 Seam program input with the "Creating/adjusting a program" function

With this function the seam program is entered by sewing a sample. A new program is always created, i.e. if an existing program is selected, this will be overwritten.

- Switch on the machine.
-  ● Call up the input mode.
-  ● Call up the "teach-in" function.
-  ● Carry out the basic settings and conclude with the "Enter" function, see Chapter 6.01.01 **Basic settings for seam program input.**

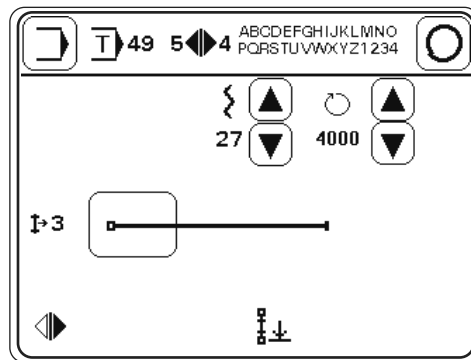
Before sewing starts the following displays and functions appear on the screen.



-  ● Enter the seam start functions, see Chapter 6.01.04 **Entering the functions at the beginning of the seam during seam programming.**
-  ● Enter the fullness, see Chapter 4.02 **Inputting fullness.**
-  ● Enter the maximum speed for the current seam section.
- Sew the first seam section using the pedal function.  
The number of stitches in the current seam section is counted and shown on the display.

After sewing starts, the following displays and functions are shown on the screen.

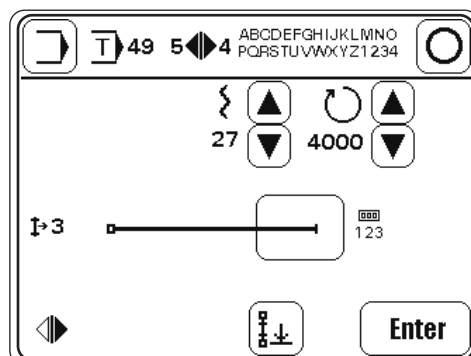

**Enter**

- By pressing Enter the seam section end is defined by stitch counting.
- By operating the pedal in position "-2", the seam section is ended by pedal operation
- By operating the knee switch, the seam section is ended by knee switch operation, see Chapter 2.01 Knee switch.
- After the function has been called up, additional inputs can be made for the seam section end or incorrect inputs can be corrected, see Chapter 6.01.05 **End of seam section input during seam programming.**



Condensed stitches defined during the input of the functions for the end of the seam section, will be carried out after the seam program input has been concluded. Up to **30** stitches will be sewn! Danger of injury in the needle area!



- Set the seam end or program end.  
If entering only one seam (only the right or only the left seam) the program end is set in the desired seam section.  
In the same way as the program end, the seam end is set when entering the right and left seam. The seam end is set in the first seam and the program end in the second seam.

**Enter**



- Conclude the input.
- Conclude the input and change to the input of the basic settings.
- Conclude the input and change to programmed sewing.



6.01.04 Entering the functions at the beginning of the seam during seam programming



After the appropriate function has been called up, the menu for entering the value of the placement stitch appears. To begin with the condensed stitches function is not activated.

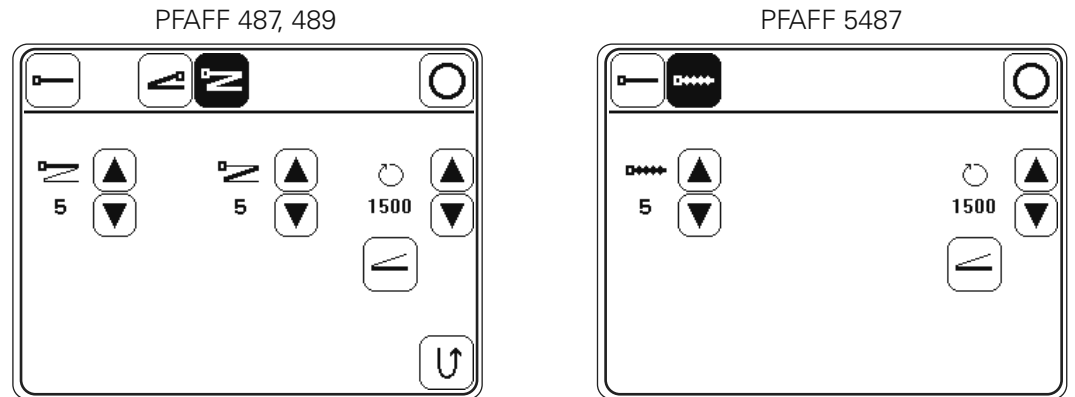

● PFAFF 487, 489



Switch on the single start backtack function and call up the menu for entering the values. (1 – 9 stitches can be entered).

or



● Switch on the double start backtack function and call up the menu for entering the values. (1 – 9 stitches can be entered).

● PFAFF 5487



Switch on the condensed stitches function and call up the menu for entering the values. (1 – 30 stitches can be entered).



● In each case change the number of stitches for the condensed stitches or the number of backtack stitches with the appropriate arrow keys.



● Change the value for the maximum speed during the condensed stitches or backtacking operation (100 – 1500 spm can be entered).



● Choose whether the condensed stitches or the backtacking operation at the beginning of the seam should be carried out at a fixed speed (normal symbol) or at a pedal-controlled speed (inverse symbol).



● If necessary, sew the seam section in reverse (with activated function).



● Conclude the input.

## 6.01.05 Entering the functions at the end of seam section during seam programming



After the appropriate function has been called up, the menu for entering the functions and values for the end of the seam section without condensed stitches appears.

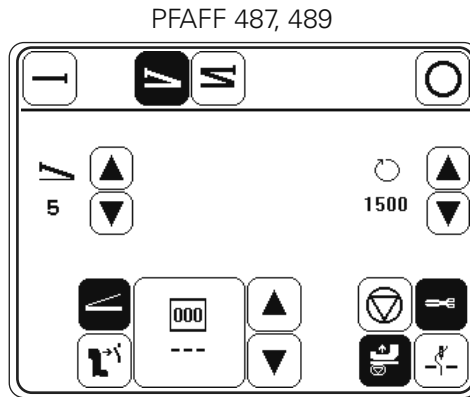

PFAFF 5487

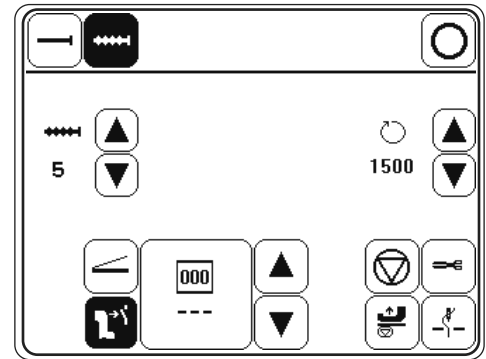

- **PFAFF 487, 489**



Switch on the single end backtrack function and call up the menu for entering the values. (1 – 9 stitches can be entered).  
or



- Switch on the double end backtrack function and call up the menu for entering the values. (1 – 9 stitches can be entered).

- **PFAFF 5487**



Switch on the condensed stitches function and call up the menu for entering the values. (1 – 30 stitches can be entered).



- In each case change the number of stitches for the condensed stitches or the number of backtack stitches with the appropriate arrow keys.



- Change the value for the maximum speed during the condensed stitches or backtacking operation (100 – 1500 spm can be entered).



- Switch the function for changing to the next seam section by pedal on or off.



- Switch the function for changing to the next seam section by knee switch on or off.



- Enter or change (with the number keys or arrow keys) the number of stitches for the seam section.



- Execute or do not execute the automatic sewing stop function at the end of the seam section.



- Switch the "sewing foot raised" function on or off, see Chapter 5.01 Manual Sewing.



- Switch the "thread trimming" function on or off, see Chapter 5.01 Manual Sewing.



- Switch the "needle raised" function on or off, see Chapter 5.01 Manual Sewing.



- Conclude the input and change to programmed sewing.



It is not possible to set every combination of functions.  
All the activated functions are shown as inverse symbols.

## 6.02 Examples of how to create a seam program

### 6.02.01 Example of a seam program input with the "creating/adjusting a program" function

The program to be created should

- have 3 seam sections and
- be stored under the program number "4" with the comment "PROG".

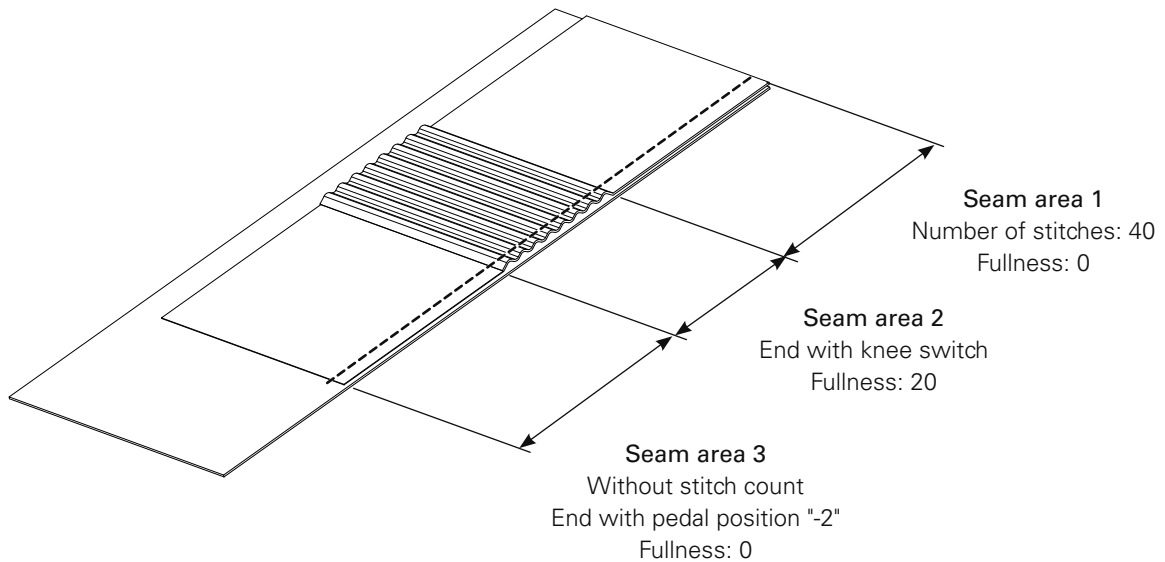

- Switch on the machine.



- Call up the input mode.



- Call up the "creating/adjusting a seam program" function and enter program number "4".

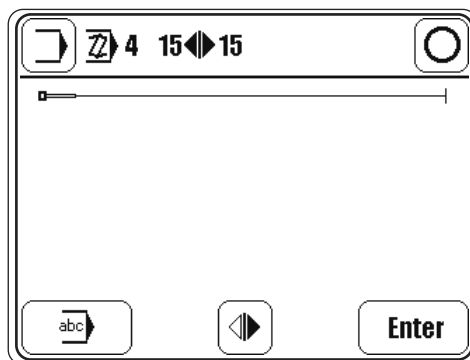

- Set the seam type (right seam) by pressing until the appropriate symbol appears.



- Call up the menu for comment input.
- Enter the comment "PROG" with the keyboard and number panel.



**Enter**

- Conclude the comment input.

**Enter**

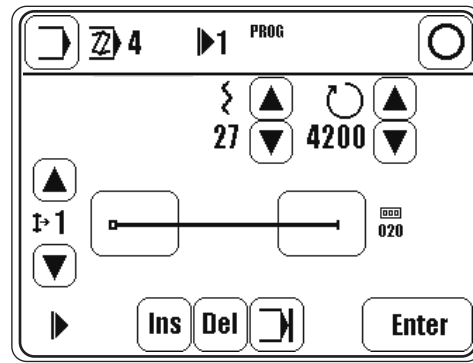
- Change to the input of the first seam section.



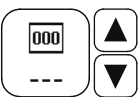

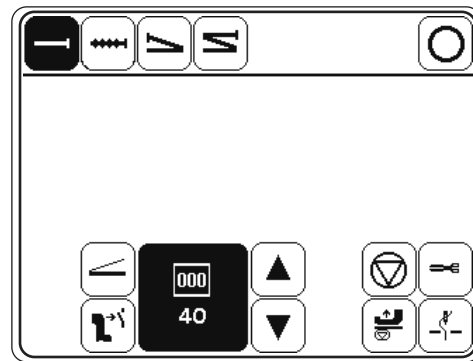

- 
  - Enter the value "0" for the fullness.
- 
  - Call up the menu for the input of the end of the seam section.
- 
  - Switch on the stitch count function to change to the next seam section, and set value "40" for the number of stitches.

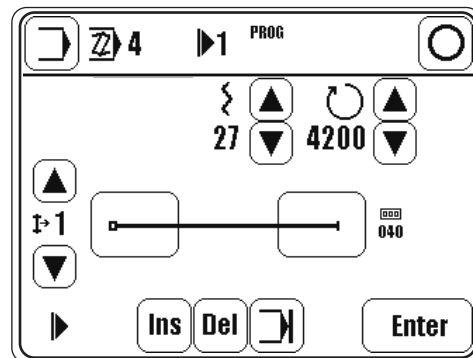

- 
  - Conclude the input of the end of the seam section.



- 
  - Change to the input of the second seam section.
- 
  - Enter the value "20" for the fullness.
- 
  - Call up the menu for the input of the end of the seam section.
- 
  - Switch on the function for changing to the next seam section with the knee switch.

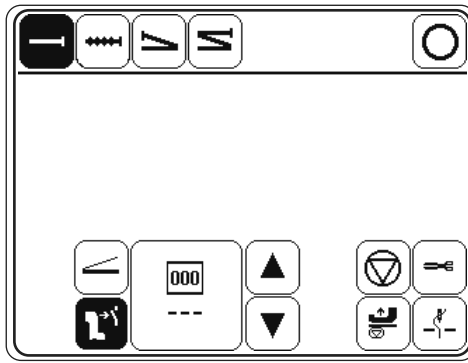

- Conclude the input of the end of the seam section.

**Enter**

- Change to the input of the third seam section.



- Enter the value "0" for the fullness.



- Call up the menu for the input of the end of the seam section.



- Switch on the function for changing to the next seam section by pedal.



- Switch on the "thread trimming" function.



- Switch on the "sewing foot raised" function.



- Conclude the input.

6.02.02 Example of a seam program input using the "teach-in" function

The program to be created should

- have **3** seam sections and
- be stored under the program number "**11**" with the comment "TEACH".

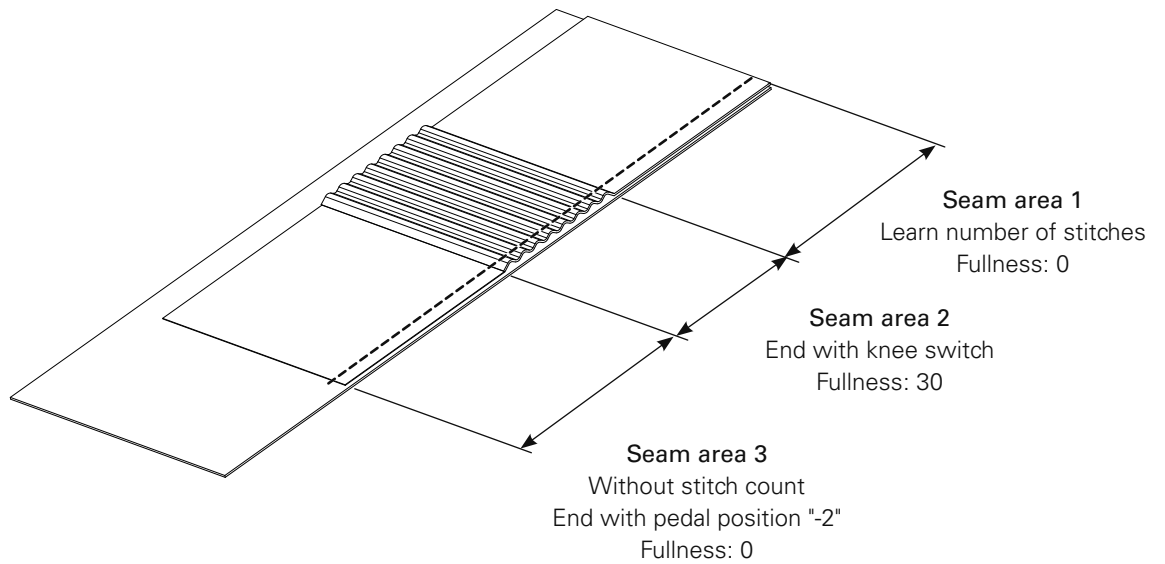

- Switch on the machine.



- Call up the input mode.



- Call up the "teach-in" function and enter program number "11".

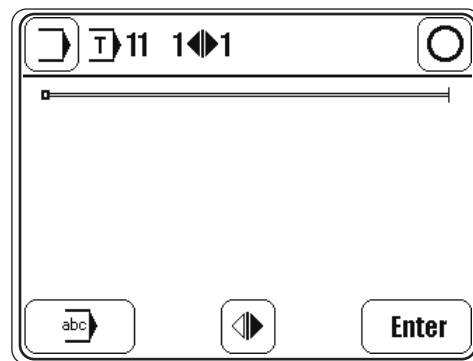

- Set the seam type (right seam) by pressing until the appropriate symbol appears.



- Call up the menu for comment input.
- Enter the comment "TEACH" with the keyboard and number panel.



- Conclude the comment input.



- Change to the input of the first seam section.

# Input



- Enter the value "0" for the fullness.
- Sew the first seam section using the pedal function.

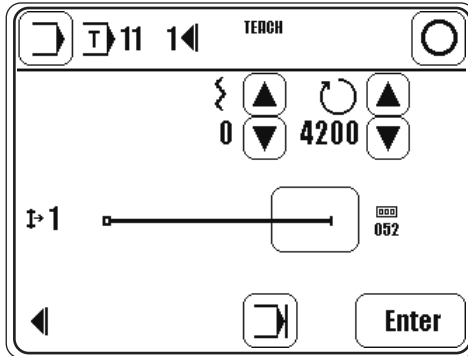

- Change to the input of the second seam section.



- Enter the value "30" for the fullness.
- Operate the knee switch



- Conclude the input of the end of the seam section.
- Use the pedal function to sew the second seam section.
- Operate the knee switch

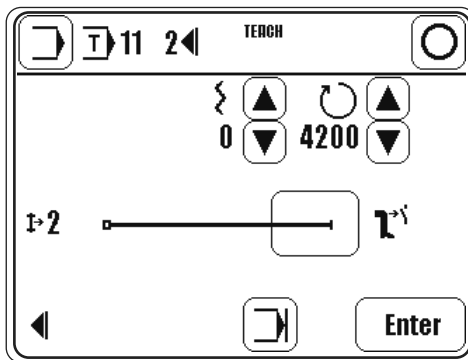

- Change to the input of the third seam section.



- Enter the value "0" for the fullness.



- Conclude the input.



6.03 Seam program administration

In the program administration the seam programs deposited in the machine memory and the SD-Card can be deleted and copied. The left side of the display shows the programs in machine memory. The right side of the display shows the programs on the SD-Card. Selected programs are red marked. With the MDAT-function the machine configuration can be copied or deleted. The Format-function formats the SD-Card. Further actions are shown in a dialog window.

After SD-Card insertion it takes up to 20s until the card is detected.

- Switch on the machine.



- Call up the input mode.



- Call up program administration.
- Read SD-Card and machine memory again.

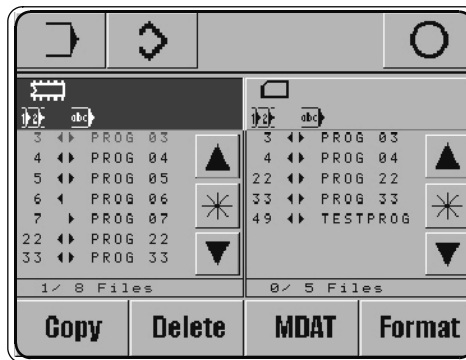

Explanation of the functions



**Input mode**  
Calls up the basic display for the input mode.



**Sewing mode**  
Quit input mode and call up sewing mode.



**Program selection**  
After the program administration has been selected, at least one seam program is always marked. Using the arrow functions, the desired seam program can be selected. With the \*-function and the arrow functions a seam program block can be marked. By pressing the \*.function again, the block function is deactivated.



**Copy**  
Selected seam programs are copied from/to SD-Card.



**Delete**  
Selected seam programs are deleted.

## Dialog window

The dialog window shows questions and additional buttons for the answers.

Enter button

### Enter

#### Enter button

Yes for one seam program.

### All

#### All button

Yes for one or all marked seam programs.

### Esc

#### Esc button

No for one or all marked seam programs.

### Next

#### Next button

No for one seam program.

### MDAT

#### Machine configuration

With the MDAT-function the machine configuration can be copied to/from SD-Card or can be deleted on the SD-Card (filename: MDAT).

### Format

#### Format SD-Card

The Format-function formats the SD-Card.

If the SD-Card is not readable, it is new formatted. If the SD-Card is readable and the directory \P487 for the 487-machine exists then all seam programs and the machine configuration (MDAT) are deleted in this directory.

If the directory \P487 for the 487-machine does not exist, only the directory \P487 is created. So all other files and directories on the SD-Card are not corrupted.

It is recommended to use SD-Cards with a maximum capacity of 2 GB.

## 7 Adjustment differing from the basic machine

## 7.01 Basic setting of the differential adjustment device

**Requirement**

With the fullness set at "0", the stitch length at "2.5" and the adjustment gauge 5 fitted, the roller 2 should be touching pressure sleeve 4.

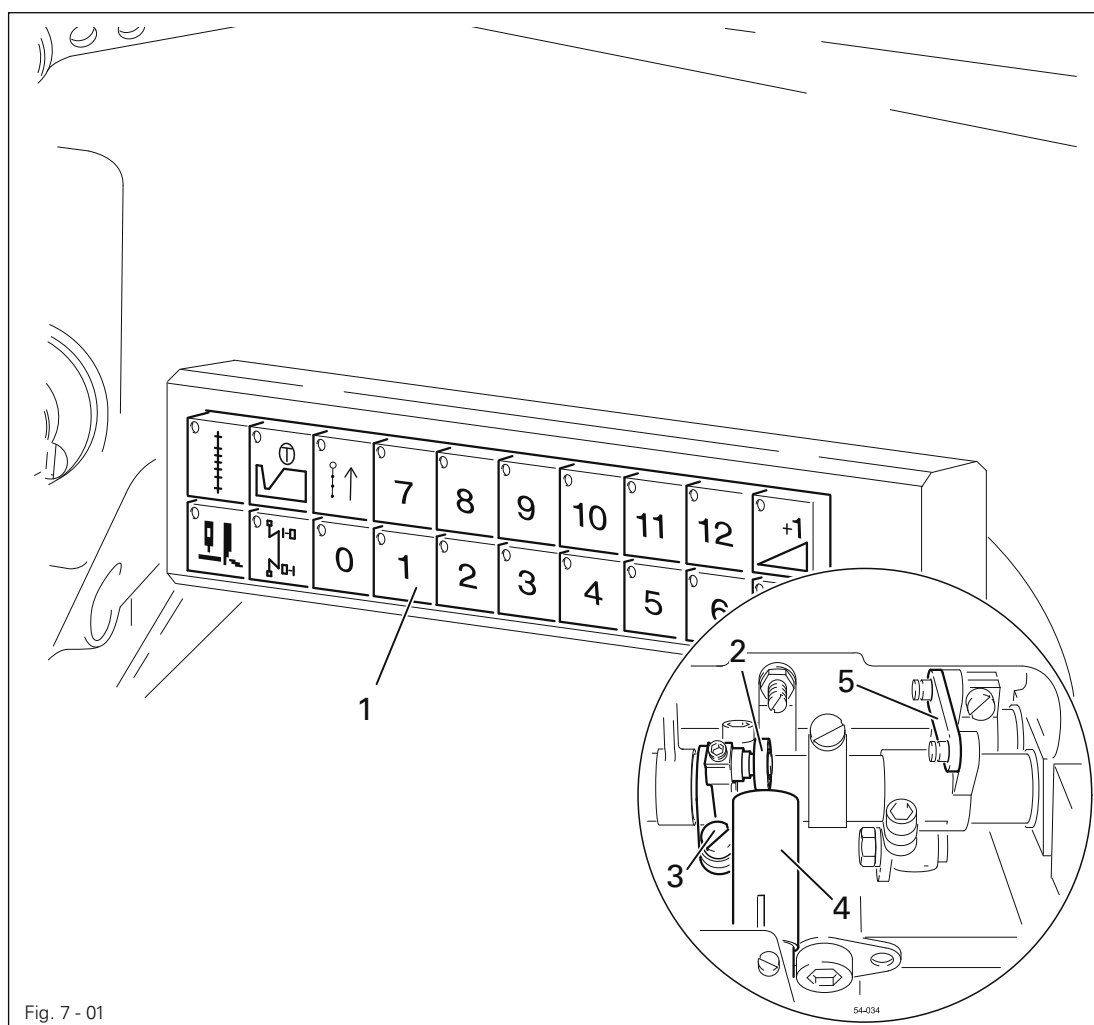
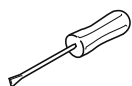

Fig. 7 - 01



- Switch on the machine.
- Press key "0" on keyboard 1 (LED must light up).
- Switch off the machine.
- Adjust roller 2 (screw 3) according to the requirement.

## 7.02 Parameter settings

### 7.02.01 Overview of the parameter functions

After the machine has been switched on, by pressing the appropriate function the input mode is called up, in which the individual parameters can be called up directly. With a code it is possible to protect all or individual parameter groups against unauthorised access.

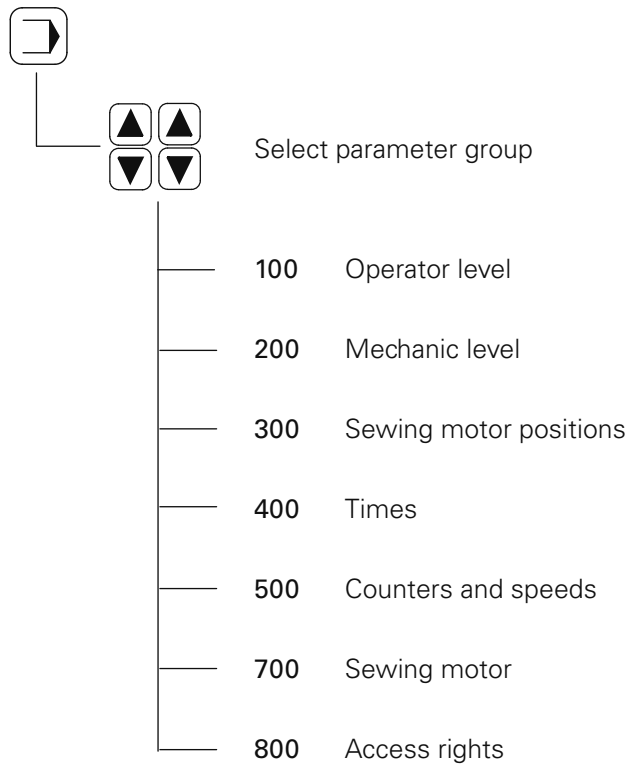

## 7.02.02 Example of a parameter input

- Switch on the machine.



- Call up the input mode.

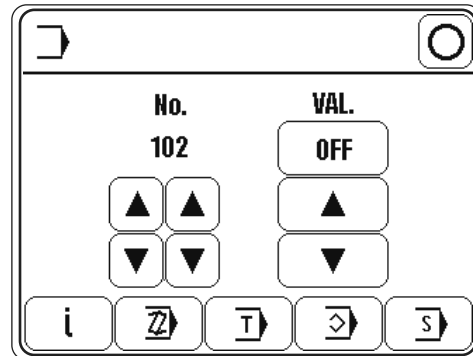

- e.g. call up parameter "113" (switch beep tone for section change on/off)

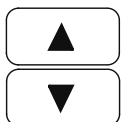
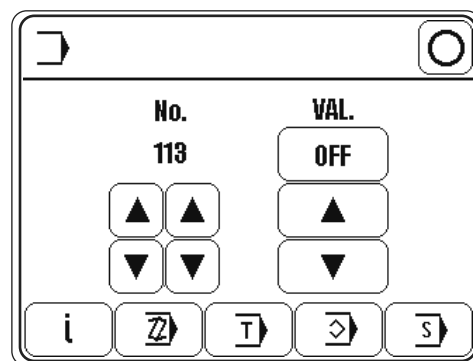

- e.g. switch beep tone on (value "ON").



- Conclude the input.



The operator has free access to the "100" parameters. Parameters "200" - "800" can only be changed after entering a code number and may only be changed by authorised personnel.

Group	Parameter	Description	Setting range	Set value
1	102	Reversing	OFF - ON	OFF
	113	Beep tone for section change	OFF - ON	OFF
	114	Max. speed forwards at each pedal positio	OFF - ON	OFF
2	201	Machine configuration 9 = 487-918/15 10 = 5487-918/15 11 = 489-918/15		
	209	Fullness adjustment value (keyboard)	0 - 9	0
	212	Not speed variation with change of fullness	OFF - ON	OFF
	213	program interruption with pedal-position -2	OFF - ON	OFF
3	301	Position "Needle point at top edge needle plate" (P320ED)	0 - 127	0
	302	Position "take-up lever t.d.c." 487, 489 5487	0 - 127	113 107
	303	Position "needle lowered" 487, 489 5487	0 - 127	24 60
	304	Reversing position	0 - 127	113
4	401	Delay time "lift foot" (s)	0,01s - 1,5s	0,02s
	402	Start delay after "lower foot" (s)	0,01s - 1,5s	0,15s
	403	Thread cutting time (on the 5487)	0,01s - 0,2s	0,15s
	404	Time for cleaning thread monitor (s)	0,01s - 1,5s	0,25s
5	501	Maximum speed 487, 489 5487	100 - 5500	4800 5500
	504	Speed soft start	100 - 5500	1500
	505	Soft start stitches	0 - 15	0

Group	Parameter	Description	Setting range	Set value
7	701	P-quota speed controller	0 - 50	16
	702	I-quota speed controller	0 - 100	50
	703	P-quota position controller	0 - 50	40
	704	D-quota position controller	0 - 100	40
	705	Time for position controller	0 - 100	25
	706	P-quota position controller for rest brake	0 - 50	25
	707	D-quota position controller for rest brake	0 - 50	15
	708	Maximum moment for rest brake	0 - 100	0
	709	Minimum machine speed	3 - 64	6
	710	Maximum machine speed 487, 489 5487	1 - 55	42 55
	711	Maximum motor speed 487, 489 5487	1 - 55	42 55
	712	Positioning speed	3 - 25	18
	713	Acceleration ramp	0 - 50	35
	714	Brake ramp	0 - 50	30
	715	Reference position	0 - 127	20
	716	Time-out	0 - 255	40
	717	Starting current motor	3 - 10	8
	718	Anti-vibration filter	1 - 10	6
	719	Rotation direction allocation	0 - 1	0
	720	Reference position correction	0 - 127	64
	721	Number of increments per revolution (Read maximum value in Service and enter here) - P323 MS	101 - 149	127

## Adjustment

Group	Parameter	Description	Setting range	Set value
8	801	Right of access function group 100	0 - 1	0
	802	Right of access function group 200	0 - 1	1
	803	Right of access function group 300	0 - 1	1
	804	Right of access function group 400	0 - 1	1
	805	Right of access function group 500	0 - 1	1
	806	Right of access service	0 - 1	1
	807	Right of access function group 700	0 - 1	1
	808	Right of access function group 800	0 - 1	1
	809	Right of access program creation	0 - 1	1
	810	Enter access code	0 - 9999	3800

### 7.04 Sewing motor errors

Message	Description
33	Invalid parameter value ▲
34	Brake path too short *
35	Communication error with limit control ▲*
36	Switch on sequence not ready ▲*
37	Too many commands ▲
64	Mains off during initialisation ▲
65	Overcurrent directly after mains on ▲*
66	Short circuit ▲*
68	Overcurrent during operation ▲*
69	No increments *
70	Motor stalling ▲*
71	No incremental plug ▲*
73	Disturbed motor running *
74	Incremental transmitter missing for speed increase/reduction ▲
75	Regulator blocked *
170	Invalid transmission *
171	Invalid zero point *
173	Motor blocked on first stitch ▲
175	Starting error ▲*
222	Time-out monitoring ▲*

▲ P320 ED, \* P323 MS



## 7.05 Explanation of the error messages

Message	Description
E001	System error
E002	Sewing motor E002/BB/xxx BB = 20: Time-out 02: Position forwards 03: Position in reverse 05: Position by shortest path 09: Write parameter 10: Speed 0A: Reset stitch counter 0B: Stop after xxx stitches 30: Time-out for increasing speed 31: Time-out for uncertain positioning 32: Time-out for time-out command 33: Time-out for deleting errors 34: Time-out for emergency stop 35: Time-out for writing parameters 36: Time-out for resetting stitch counter 37: Time-out for stop command after x stitches 38: Time-out for initialization xxx = error bytes of sewing motor control unit (see list "Motor Errors")
E003	Section
E004	End of section
E005	Pedal activated when machine switched on
E006	Keyboard (CAN)
E007	End of ramp
E008	Reference for fullness adjustment not found 1: When moving towards sensor 2: When moving away from sensor
E011	Stepping motor stepping frequency too high
E012	not assigned
E014	Incorrect program number (larger than 49)
E015	Incorrect seam section number
E016	Memory full
E017	not assigned
E018	not assigned
E020	not assigned
E021	Power supply unit overloaded (24V)
E022	Mains voltage
E023	Power supply 24V too low
E024	Error at CAN interface

---

## Adjustment

---

### 7.06 Table of inputs

E1:	not assigned
E2:	not assigned
E3:	not assigned
E4:	Start inhibitor
E5:	not assigned
E6:	Knee switch
E7:	not assigned
E8:	not assigned
E9:	not assigned
E10:	not assigned
E11:	not assigned
E12:	not assigned
E13:	not assigned
E14:	not assigned
E15:	not assigned
E16:	Reference for fullness adjustment

### 7.07 Table of outputs

O1:	Raise sewing foot (O1.1 and O1.2)
O2:	Thread trimmer (O2.1 and O2.2)
O3:	not assigned
O4:	not assigned
O5:	Backtacking device (only 487, 489)
O6:	Condensed stitches (only 5487)
O7:	not assigned
O8:	not assigned
O9:	not assigned
O10:	not assigned
O11:	not assigned
O12:	not assigned
O13:	not assigned
O14:	not assigned
O15:	not assigned
O16:	not assigned

## 7.08 Service menu

- Switch on the machine.



- Call up the input mode.



- Call up the service menu.

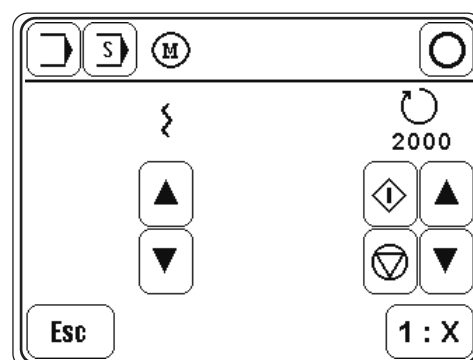
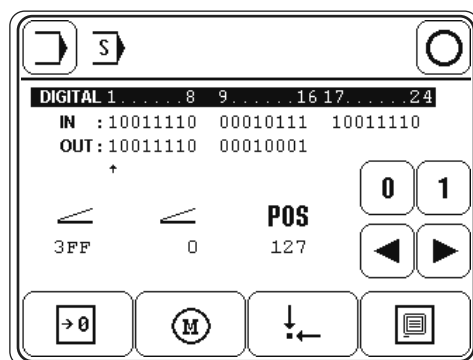

## Explanation of the functions

**Input mode**

Quit the service menu and call up the input

**Sewing mode**

Quit the service menu and call up the sewing mode.

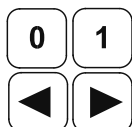
**Set/reset outputs**

Use the arrow functions to select the desired output and set "function 1" or reset "function 2".

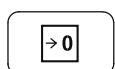
**Cold start**

See Chapter 7.09 Carry out a cold start.

**Motors**

After this function has been called up, the stepping motors for fullness and for the sewing motor can be moved.

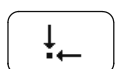
**Basic position of the stepping motor**

After this function has been called up, the basic position of the fullness stepping motor can be changed.

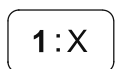
**Learning speed increase (in Motor menu)**

Press this key to learn the speed increase function on machines with the control unit P320ED. For this purpose the sewing drive sews 3 stitches at a speed of 360 min<sup>-1</sup>.

**Control panel**

See Chapter 4.04 Adjusting the control panel.

## 7.09 Carry out a cold start

- Switch on the machine.



- Call up the input mode.

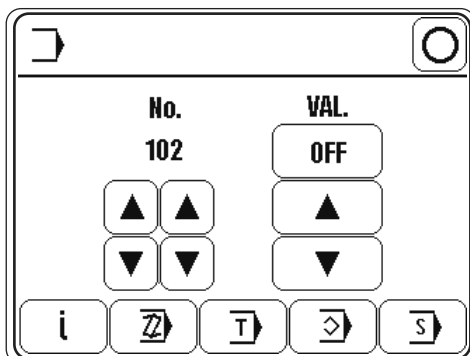

- Call up the service menu.

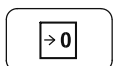
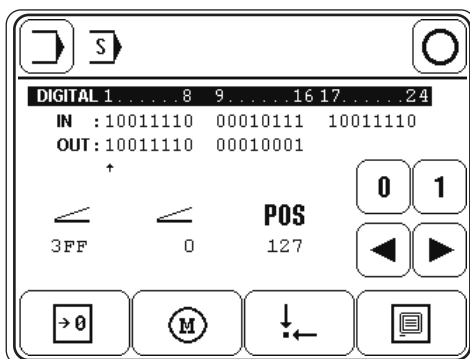

- Carry out a cold start.



After a cold start all programmed values are set back to their status at the time of delivery.  
All sewing programs are also deleted.

## 7.10 Internet update of the machine software

The machine software can be updated with PFAFF flash programming. For this purpose the PFP boot program and the appropriate control software for the machine type must be installed on a PC. To transfer the data to the machine, the PC and the machine control unit must be connected with an appropriate null modem cable ( part no. **91-291 998-91** ).



The PFP boot program and the control software of the machine type can be downloaded from the PFAFF-homepage using the following path: [www.pfaff-industrial.de/pfaff/de/service/downloads](http://www.pfaff-industrial.de/pfaff/de/service/downloads)

To update the machine software carry out the following steps:



While the machine software is being updated, no setting up, maintenance or adjustment work may be carried out on the machine!

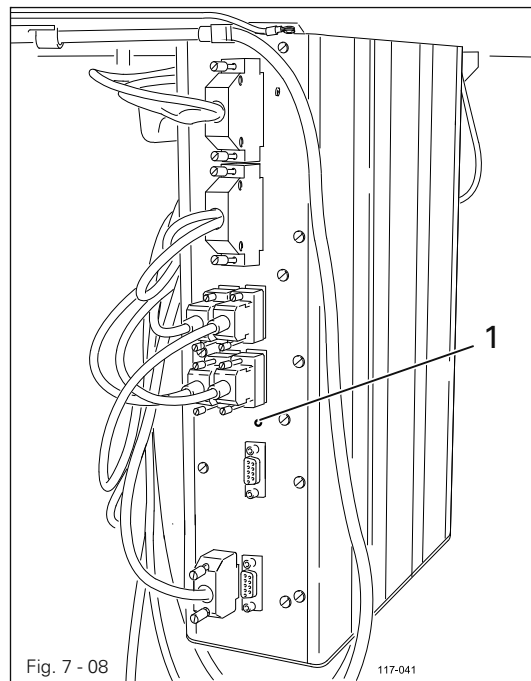

- Switch off the machine.
- Connect the PC (serial interface or appropriate USB-adapter) and the machine control unit (RS232). To do so disconnect the plug of the control panel.
- Switch on the PC and start the PFP boot program.
- Select the machine type.
- Press the "programming" button.
- Hold down boot key 1 and switch on the machine.
- Press the "OK" button.
- The software update is carried out, the update progress is shown on the bar display of the PFP boot program.

- During the up-dating procedure the machine must not be switched off.
- When the update has been completed, switch off the machine and end the PFP boot program.
- End the connection between the PC and the machine control unit and reconnect the control panel to the machine control unit.
- Switch on the machine.
- A plausibility control is carried out and, if necessary, a cold start.



More information and assistance is at your disposal in the file "PFPHILFE.TXT", which can be called up from the PFP boot program by pressing the "help" button.

### 8 Circuit diagrams

#### 8.01 Reference list for circuit diagrams 91-191 525-95

A1	Controller Quick P 320MS
A2	Control panel (BDF T1)
A3	Keyboard
A14	Sewing head identification (OTE)
H1	Sewing lamp
M1	Sewing motor
M3	Stepping motor fullness adjustment (SM1)
Q1	Main switch
S6	Knee switch (program switching)
S17	Pedal speed control unit
S18	Synchronizer PD3
X1	Mains plug
X1A	RS232 – interface 1 Control panel BDF T1
X1B	VSS OTE (Sewing head identification)
X3	Incremental transmitter (control unit)
XR3	Incremental transmitter (sewing motor)
XS3	Synchronizer PD3
X4B	Stepping motor fullness (SM1)
X5	Inputs
X8	Sewing motor
X11A	CAN interface (Keyboard)
X11B	Pedal speed control unit
X13	Outputs
X21	Stepping motor fullness (SM1) )
X22	Keyboard
X36	Knee switch (program switching)
X46	Initiator reference (SM1)
X51	Y1 -910/.. Automatic presser foot lift
X52	Y2 -900/.. Thread trimmer
X55	Y5 -911/.. Backtacking unit
Y1	-910/.. Automatic presser foot lift
Y2	-900/.. Thread trimmer
Y5	-911/.. Backtacking unit

8.01.02 Circuit diagrams 91-191 525-95

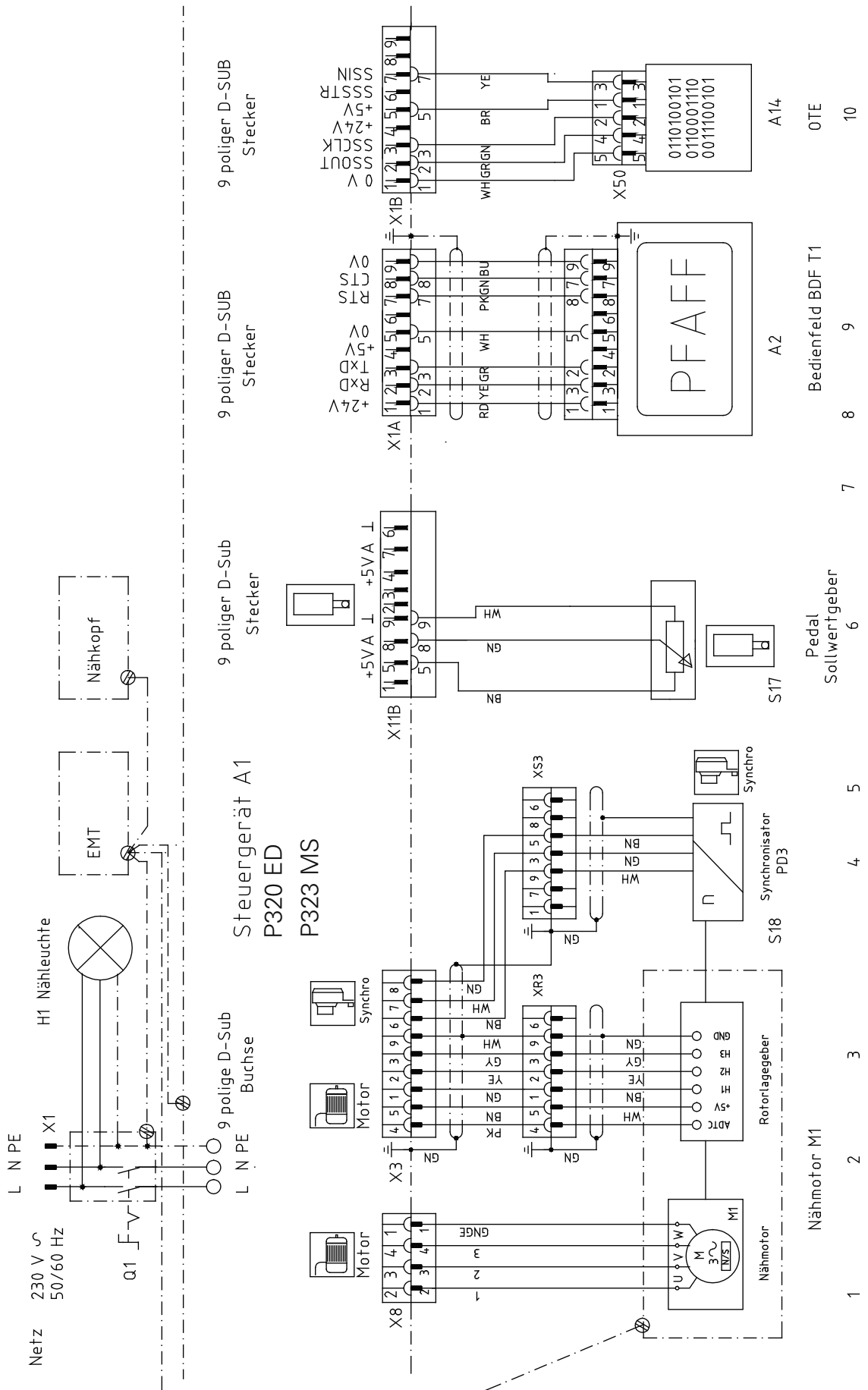

- 1 Nähmotor
- 2 Nähmotor M1
- 3 Rotorlagegeber
- 4 Synchronisator PD3
- 5 Synchronmotor
- 6 Pedal Sollwertgeber
- 7 S17
- 8 Bedienfeld BDF T1
- 9 A2
- 10 OTE

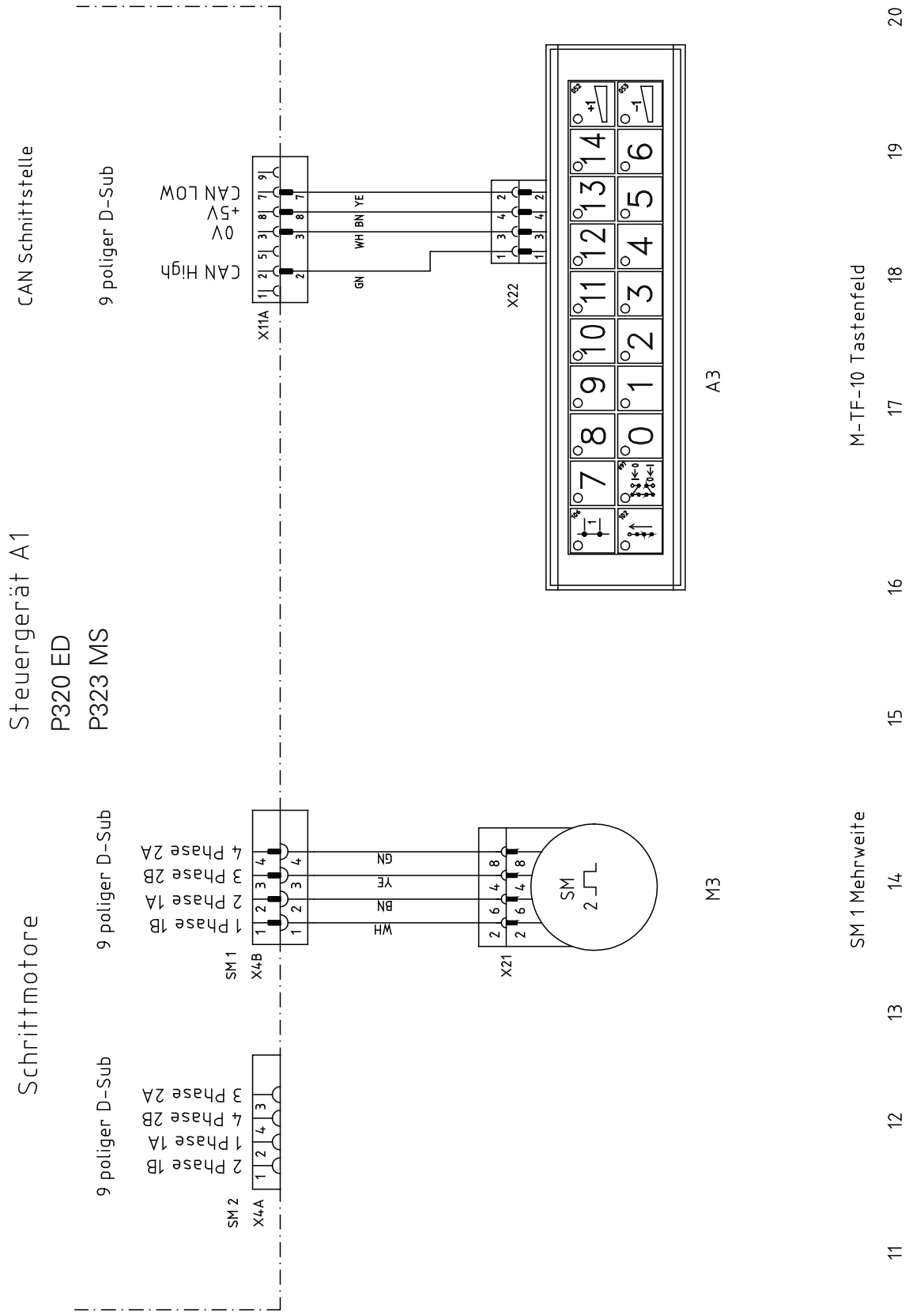



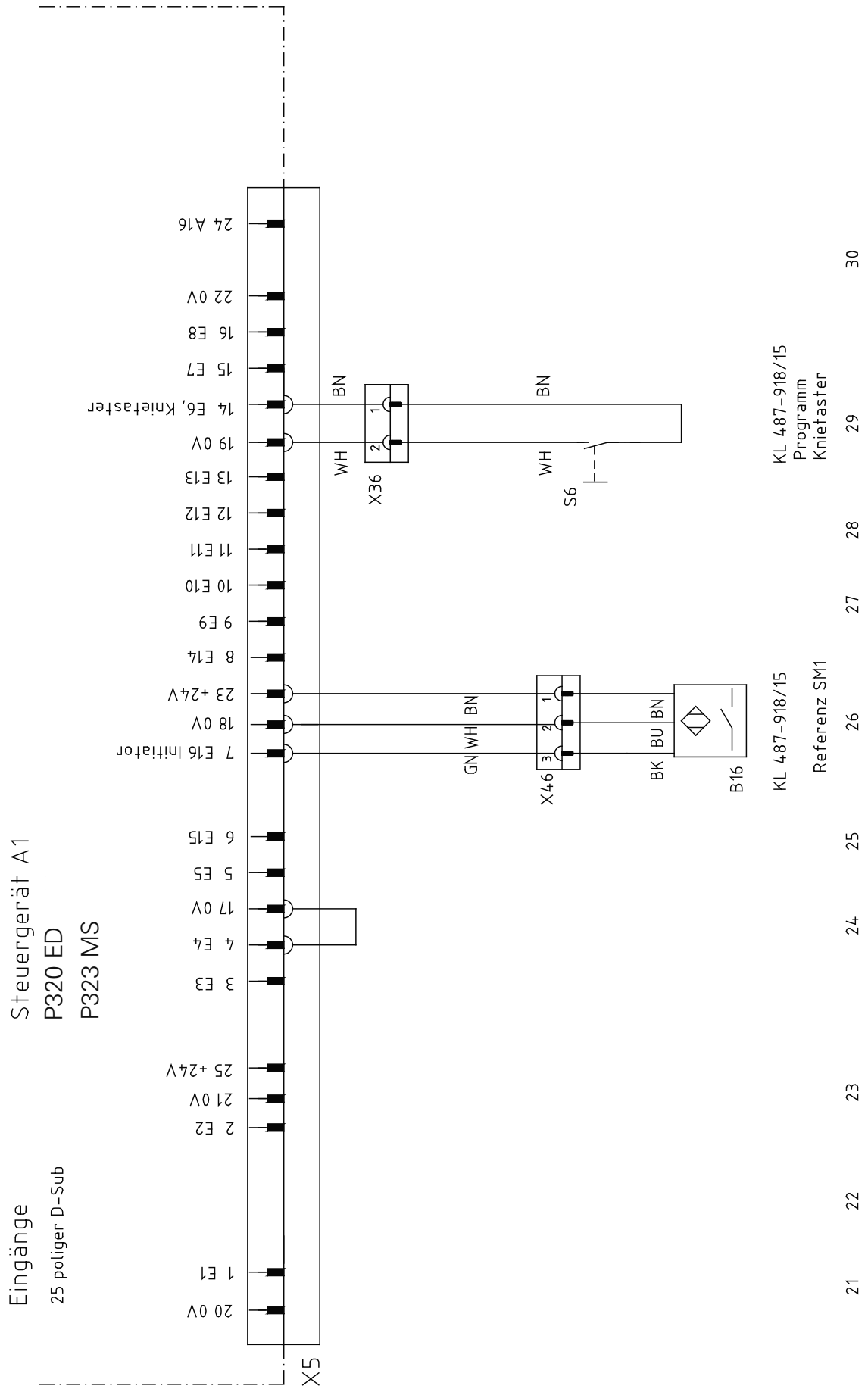

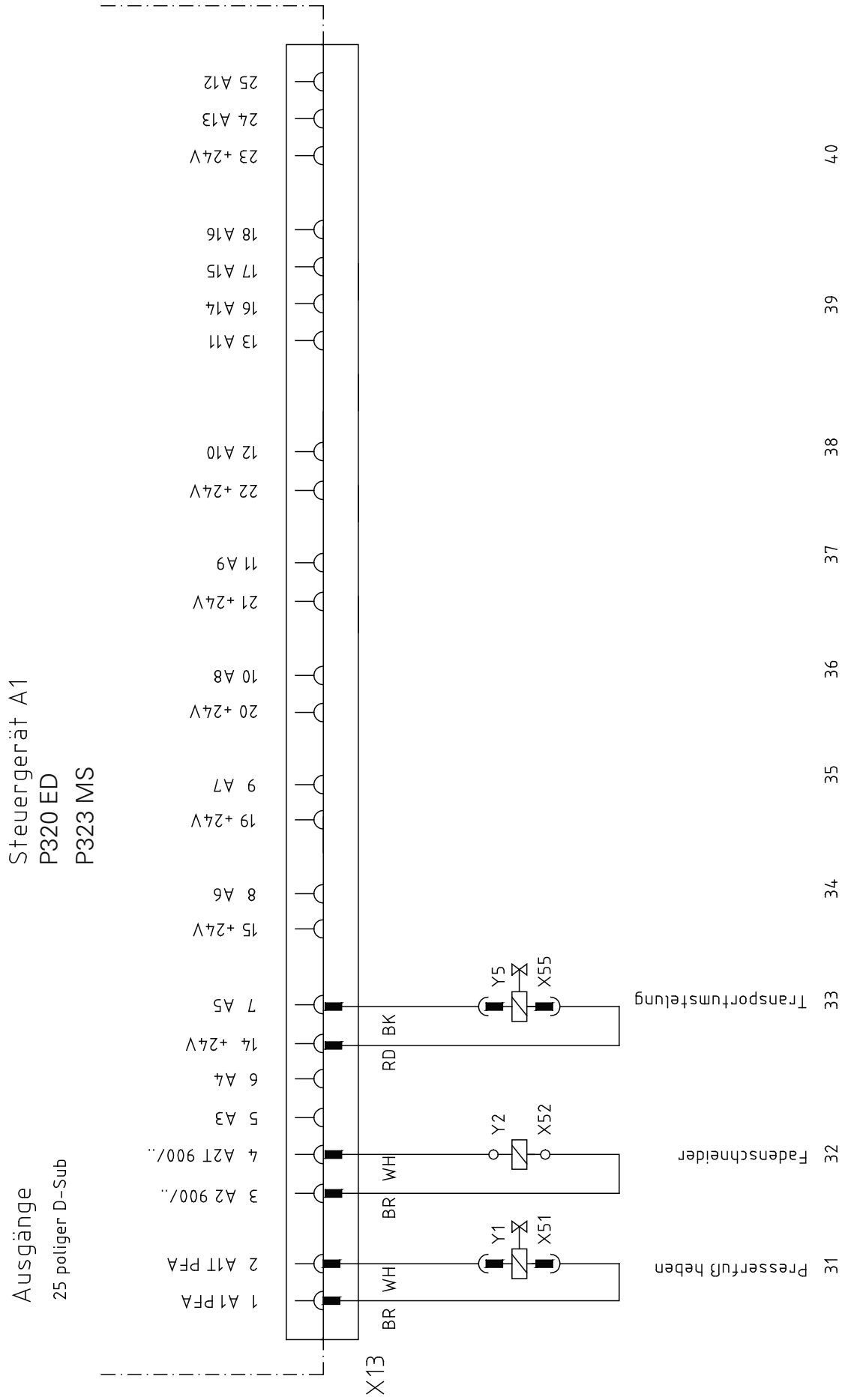





**Europäische Union**  
Wachstum durch Innovation – EFRE



## PFAFF Industriesysteme und Maschinen AG

Hans-Geiger-Str. 12 - IG Nord  
D-67661 Kaiserslautern

Telefon: +49-6301 3205 - 0  
Telefax: +49-6301 3205 - 1386  
E-mail: [info@pfaff-industrial.com](mailto:info@pfaff-industrial.com)