

6-1-4. Memory switch setting level table and contents

Function No.	Function	Item	Start level 1	Start level 2	Page No.
0	Memory	1. Initialization of RAM		○	134
		2. Initialization of EEPROM		○	134
1	Jog function	1. Jog mode	○		135
2	X coordinate of receding position	1. Coordinate		○	136
3	Y coordinate of receding position	1. Coordinate		○	136
5	Retainer compensation	1. Mode	○		137
6	Returning route to the sewing start point	1. At the end of sewing	○		138
		2. Travel limit error	○		138
7	Returning route from a midpoint in sewing	1. Mode		○	139
8	Mechanical origin compensation	1. Amount of X compensation		○	140
		2. Amount of Y compensation		○	140
13	Enlargement/reduction	1. Mode	○		141
21	Cycle sewing	1. Performance of feeding frame (cycle sewing)	○		142
22	Thread trimming command	1. Switch	○		143
30	Bobbin thread counter	1. Counting	○		144
31	Floppy disk data reading operation	1. Selection of function		○	145
		2. Regular reading	○		145
33	Automatic pattern reading from floppy disk	1. Mode		○	146
35	Idling operation	1. Speed changing		○	147
36	Thread trimming at the time of temporary stop	1. Thread trimming action	○		147
40	Selection of sewing speed	1. Acceleration at the sewing start	○		148
		2. Selection of feed pitch/sewing speed	○		148
41	Feed control	1. Feeding position	○		148
42	Thread trimmer control	1. Control	○		149
43	Feeding frame control	1. Operation sequence	○		150
		2. Feeding frame holding state at the end of sewing	○		150
		3. Regular holding	○		150
44	Intermediate presser control	1. Control	○		151
		2. Operation timing	○		151
45	Wiper	1. Sweeping position	○		152
		2. Sweeping position	○		152
46	Thread clamp performance	1. Switch	○		153
		2. Thread clamp mechanism	○		153
47	Selection of thread breakage detecting function control	1. Switch	○		154
		2. Setting the number of stitches required to stop the machine (at the start)		○	154
		3. Setting the number of stitches required to stop the machine (during normal operation)		○	154

Function No.	Function	Item	Start level 1	Start level 2	Page No.
48	Selection of air pressure detecting function	1. Switch	○		155
49	Selection of needle-up position detecting function	1. Switch	○		155
51	Inverting mechanism control	1. Switch	○		156
53	Tension controller No. 3 control	1. Switch		○	156
55	Buzzer control	1. Switch		○	157
56	Selection of floppy disk data reading sequence	1. Retrieving sequence	○		157
81	Wiper (magnet) sweeping action	ON/OFF timing		○	158
82	Wiper (air) sweeping action	ON/OFF timing		○	159
84	Intermediate presser action timing	ON/OFF timing		○	160

### 6-1-5. Explanation of the memory switches

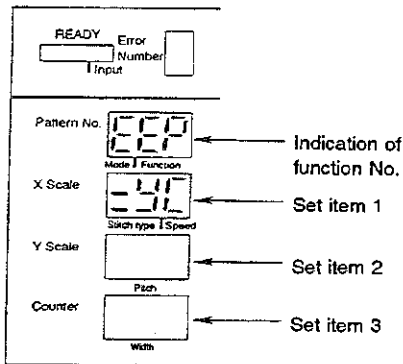

The pattern No. display gives the function No. of memory switches. Each function has as many as three different set items. The set values are shown on the X Scale, Y Scale and Counter displays. If the function does not have all of the three set items, "---" will appear on the display corresponding to the lacking set item.

Example:

- 001: Indicates the selection of the jog function.
- 002: Indicates the second origin setting.

### 6-1-6. How to use the memory switch

#### Specifying the memory switch

Pressing the  key, turn ON the power switch. The indication shown in the figure below will appear on the operation panel.

At this time, the level 1 actuates when the rotary DIP switch mounted on the I/F circuit board is set to "0," or the level 2 actuates when it is set to "3." Note that the level 2 includes the functions that actuate on the level 1.

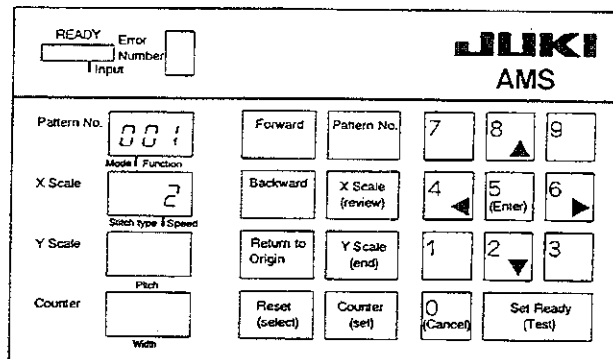



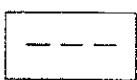
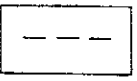

#### 1) Explanation of the LED indications

Name of LED indication	Description
Pattern No.	Indicates a function No. of the memory switch.
X Scale	Indicates the set value for item 1 of the function No. shown on the Pattern No. LED.
Y Scale	Indicates the set value for item 2 of the function No. shown on the Pattern No. LED. Note that the indication illustrated below will appear on the Y Scale LED when no item 2 exists.  Pitch
Counter	Indicates the set value for item 3 of the function No. shown on the Pattern No. LED. Note that the indication illustrated below will appear on the Counter LED when no item 3 exists.  Width

2) Function of the setting switches and how to operate them

Name of switch	Function	Operation
<div style="border: 1px solid black; padding: 2px; width: fit-content; margin: 5px auto;">Pattern No.</div>	<ul style="list-style-type: none"> <li>Used to change the function No. of the memory switch shown on the Pattern No. LED.</li> </ul> <p>Select a function No. using the <div style="border: 1px solid black; padding: 2px; display: inline-block; font-size: small;">Pattern No.</div> switch and <div style="border: 1px solid black; padding: 2px; display: inline-block; text-align: center;">2 ▼</div> or <div style="border: 1px solid black; padding: 2px; display: inline-block; text-align: center;">8 ▲</div> key.</p>	<ul style="list-style-type: none"> <li>To change the function No. from 41 to 46</li> </ul> <p>Press the <div style="border: 1px solid black; padding: 2px; display: inline-block; font-size: small;">Pattern No.</div> switch.</p> <p style="text-align: center;">↓</p> <p>Press the <div style="border: 1px solid black; padding: 2px; display: inline-block; text-align: center;">8 ▲</div> key five times.</p>
<div style="border: 1px solid black; padding: 2px; width: fit-content; margin: 5px auto;">X Scale (review)</div>	<ul style="list-style-type: none"> <li>Used to change the set value for item 1 of the function No. shown on the X Scale LED.</li> </ul> <p>Select a function No. using the <div style="border: 1px solid black; padding: 2px; display: inline-block; font-size: small;">X Scale (review)</div> switch and <div style="border: 1px solid black; padding: 2px; display: inline-block; text-align: center;">2 ▼</div> or <div style="border: 1px solid black; padding: 2px; display: inline-block; text-align: center;">8 ▲</div> key.</p>	<ul style="list-style-type: none"> <li>To change the set value from 2 to 0</li> </ul> <p>Press the <div style="border: 1px solid black; padding: 2px; display: inline-block; font-size: small;">X Scale (review)</div> switch.</p> <p style="text-align: center;">↓</p> <p>Press the <div style="border: 1px solid black; padding: 2px; display: inline-block; text-align: center;">2 ▼</div> key twice.</p>
<div style="border: 1px solid black; padding: 2px; width: fit-content; margin: 5px auto;">Y Scale (end)</div>	<ul style="list-style-type: none"> <li>Used to change the set value for item 2 of the function No. shown on the Y Scale LED.</li> </ul> <p>Select a function No. using the <div style="border: 1px solid black; padding: 2px; display: inline-block; font-size: small;">Y Scale (end)</div> switch and <div style="border: 1px solid black; padding: 2px; display: inline-block; text-align: center;">2 ▼</div> or <div style="border: 1px solid black; padding: 2px; display: inline-block; text-align: center;">8 ▲</div> key.</p>	<ul style="list-style-type: none"> <li>To change the set value from 3 to 1</li> </ul> <p>Press the <div style="border: 1px solid black; padding: 2px; display: inline-block; font-size: small;">Y Scale (end)</div> switch.</p> <p style="text-align: center;">↓</p> <p>Press the <div style="border: 1px solid black; padding: 2px; display: inline-block; text-align: center;">2 ▼</div> key twice.</p>
<div style="border: 1px solid black; padding: 2px; width: fit-content; margin: 5px auto;">Counter (set)</div>	<ul style="list-style-type: none"> <li>Used to change the set value for item 3 of the function No. shown on the Counter LED.</li> </ul> <p>Select a function No. using the <div style="border: 1px solid black; padding: 2px; display: inline-block; font-size: small;">Counter (set)</div> switch and <div style="border: 1px solid black; padding: 2px; display: inline-block; text-align: center;">2 ▼</div> or <div style="border: 1px solid black; padding: 2px; display: inline-block; text-align: center;">8 ▲</div> key.</p>	<ul style="list-style-type: none"> <li>To change the set value from 2 to 6</li> </ul> <p>Press the <div style="border: 1px solid black; padding: 2px; display: inline-block; font-size: small;">Counter (set)</div> switch.</p> <p style="text-align: center;">↓</p> <p>Press the <div style="border: 1px solid black; padding: 2px; display: inline-block; text-align: center;">8 ▲</div> key four times.</p>

Name of switch	Function	Operation
<div style="border: 1px solid black; padding: 5px; width: fit-content; margin: 10px auto;">Set Ready (Test)</div>	<ul style="list-style-type: none"> <li>Used to terminate the memory switch setting procedure.</li> </ul> <div style="border: 1px solid black; padding: 10px; margin: 10px auto; width: 80%;"> <div style="display: flex; justify-content: space-between; align-items: center;"> <span>READY</span> <span>Error</span> <div style="border: 1px solid black; width: 20px; height: 20px;"></div> </div> <div style="display: flex; justify-content: space-between; align-items: center;"> <div style="border: 1px solid black; width: 40px; height: 20px;"></div> <span>Number</span> </div> <div style="text-align: center; margin-top: 5px;">↓ Input</div> </div> <div style="border: 1px solid black; padding: 5px; margin: 10px auto; width: 80%;"> <div style="display: flex; justify-content: space-between;"> <span>Pattern No.</span> <div style="border: 1px solid black; padding: 2px;">000</div> </div> <div style="display: flex; justify-content: center; margin-top: 5px;"> <span>Mode</span>   <span>Function</span> </div> <div style="display: flex; justify-content: space-between;"> <span>X Scale</span> <div style="border: 1px solid black; padding: 2px;">40</div> </div> <div style="display: flex; justify-content: center; margin-top: 5px;"> <span>Stitch type</span>   <span>Speed</span> </div> <div style="display: flex; justify-content: space-between; margin-top: 10px;"> <span>Y Scale</span> <div style="border: 1px solid black; width: 40px; height: 20px;"></div> </div> <div style="display: flex; justify-content: center; margin-top: 5px;"> <span>Pitch</span> </div> <div style="display: flex; justify-content: space-between; margin-top: 10px;"> <span>Counter</span> <div style="border: 1px solid black; width: 40px; height: 20px;"></div> </div> <div style="display: flex; justify-content: center; margin-top: 5px;"> <span>Width</span> </div> </div>	<p>Press the  switch.</p> <p>Indication shown in the figure given on the left will appear on the operation panel.</p> <ul style="list-style-type: none"> <li>To make the set values effective</li> </ul> <p>Press the  switch.</p> <ul style="list-style-type: none"> <li>To make the set values ineffective and return the machine to the state before starting up the memory switch setting mode</li> </ul> <p>Press the  key.</p> <p>Press the  switch twice.</p> <p>The memory switch setting mode will terminate and the machine will return to the state where the machine enters immediately after the power to the machine has been normally turned ON.</p>

**[Note]**

A number shown on the LED can be continuously increased/decreased by keeping the  or  key held pressed.

**[Caution to be taken when using the memory switches]**

Function No. that is not described in the Engineer's Manual may be shown on the display. However, never change the setting of the set items available under the function No. Changing the setting might impair the normal operation of the sewing machine. If you change any of those settings unintentionally, be sure to perform initialization following the procedure described below. After the initialization, all the memory switches will be initialized to their initial state.



















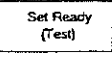

**[How to initialize the memory switches]**

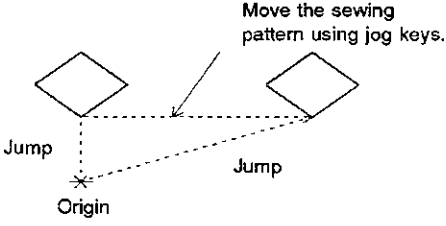
It is possible to initialize the memory switches using item 2 of memory switch function No. 0 (initialization of memory switches). Determine the set value of item 2 in accordance with the specifications of the type of your sewing machine and terminate the memory switch setting procedure. Then, input data. This returns all the memory switches to their initial state.

**[Caution]**

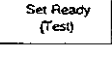
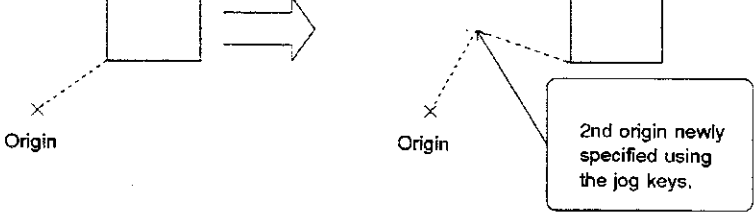
If the memory switches have been separately specified, write down the respective set values on a sheet of paper or the like. Then, start the aforementioned operation.

1) Operation setting		(Level 2)			
Function No. 0	Function: Initialization of memory				
Item: 1 Initialization of RAM					
Set value	0	Regular initialization			
		<p>[Description]</p> <p>Whenever the power to the machine is turned ON, the machine initializes the RAM at all times.</p> <p>Example: Use this set item only for maintenance. Do not use it in normal times.</p>			
Set value	1	Initialization is not performed. (Standard set value)			
		<p>[Description]</p> <p>The RAM is not initialized and the backup data are stored in memory. Note that the RAM is automatically initialized in care where the backup data is failed.</p>			
Item: 2 Initialization of EEPROM					
		<p>Data setting range 0 to 10</p> <p>This function allows the memory switches to be changed to set values adaptable to the type of machine by writing data on the respective types of machines into EEPROM.</p> <p>After the completion of initialization, set value A will return to "0."</p>			
Set value A	Specification	Main motor control: 40	Feeding frame control: 43	Intermediate presser control: 44	Wiper: 45
		Acceleration at the sewing start: 1	Operation sequence: 1	Control: 1	Sweeping position: 2
		Set value B	Set value C	Set value D	Set value E
1	AMS-215CSS/CHS (with a monolithic feeding frame)	0	0	1	0
2	AMS-215CLS/CHL (with a separately-driven feeding frame)	0	2	1	0
3	AMS-215CBS/CHB (with a double-stepped stroke feeding frame)	0	1	1	0
4	AMS-215CSL/CHL (with a double-stepped stroke separately-driven feeding frame)	0	8	1	0
5	AMS-215CST/CHT (with a double-stepped stroke separately-driven feeding frame)	0	8	0	1
6	AMS-215CGL (with a separately-driven feeding frame)	0	8	1	1
7	AMS-215C (for embroidering)	1	2	1	0
		<p>[Caution]</p> <p>The aforementioned functions have been factory-set at the time of delivery. So use the functions only when the specifications of your machine is changed by replacing the control box or modifying the machine head.</p>			

1) Operation setting		(Level 1)
Function No. 1	Function: Jog function	
Item: 1	Jog mode	
Set value	0	<p>Jog function is ineffective.</p> <p>[Description] The jog keys (  ,  ,  and  ) are inoperative.</p>
	1	<p>Pattern travel</p> <p>[Description] A sewing pattern can be moved to a specified position by operating the jog keys (  ,  ,  and  ).</p> <p>Pattern data read from a floppy disk is moved to a new location by adding a distance by which the pattern data is to be moved using the jog function.</p> <p>The second origin contained in the pattern data is rendered ineffective. This setting can be reset by turning ON then OFF the  switch.</p> <p>The setting can also be canceled when reading another sewing pattern.</p> <p>To change the setting, create a new "point" using jog keys (  ,  ,  and  ). This erases the previously set point.</p> <p>After you have input data, the newly specified "point" is stored in memory together with the original pattern due to the "backup function" even turning OFF the power to the machine.</p> <p>[Example]</p> 
	2	<p>The 2nd origin setting (standard set value)</p> <p>[Description] The position specified using the jog keys (  ,  ,  and  ) is set as the 2nd origin.</p> <p>A 2nd origin is specified for the convenience's sake during jump from the origin of the sewing pattern read from a floppy disk to the sewing start point without actually moving the sewing pattern.</p> <p>In this case, the 2nd origin contained in the pattern data will be ineffective. This setting can be reset by turning ON then OFF the  switch.</p> <p>[Example]</p> 
3	<p>The 2nd origin setting</p> <p>[Description] A 2nd origin is specified in accordance with the set values of X and Y written in EEPROM.</p> <p>[Caution] <b>When this code is used, the 2nd origin specified in a sewing pattern is rendered ineffective.</b></p> <p>In this data setting procedure, jog keys (  ,  ,  and  ) are not operative.</p> <p>A 2nd origin is set in accordance with the set values of function Nos. 2 and 3.</p>	

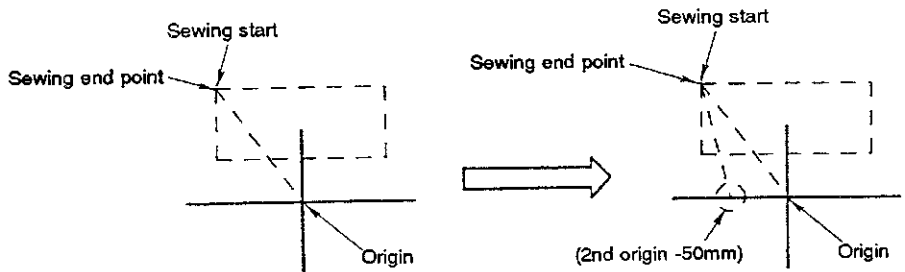
1) Operation setting		(Level 2)
Function No. 2	Coordinate of the location of 2nd origin	
Item: 1	Setting an X coordinate of the location of 2nd origin	
Set value	-32767 ~ +32767	Setting the location of 2nd origin (X coordinate) (Standard set value 0)
		<p>[Description]</p> <p>When the set value of jog mode (No. 1) of the memory switch is 3, an X coordinate specified for this item determines the location of 2nd origin. The X coordinate is shown with five figures number on the XY Scale LED.</p> <p>Unit: Set value × 0.1 mm</p> <p>[Example]</p>  <p>After the location of the 2nd origin is specified (When the location of the 2nd origin is set to a point X=-500, Y=0)</p>

1) Operation setting		
Function No. 3	Coordinate of the location of 2nd origin	
Item: 1	Setting a Y coordinate of the location of 2nd origin	
Set value	-32767 ~ +32767	Setting the location of 2nd origin (Y coordinate) (Standard set value 0)
		<p>[Description]</p> <p>When the set value of jog mode (No. 1) of the memory switch is 3, a Y coordinate specified for this item determines the location of 2nd origin. The Y coordinate is shown with a five-figure number on the XY Scale LED.</p> <p>Unit: Set value × 0.1 mm</p>



1) Operation setting (Level 1)



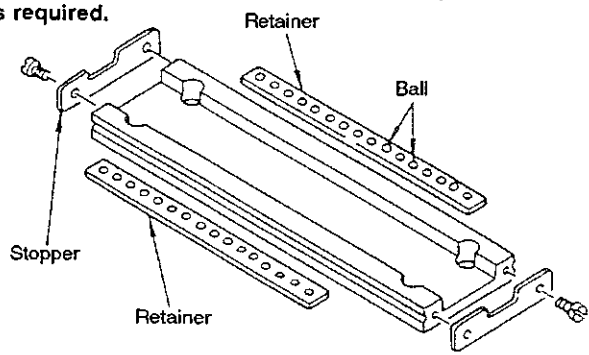

Function No. 5

Item: 1

0	<p>Retainer compensation function is inoperative.</p> <p><b>[Description]</b>                  Retainer compensating performance is prohibited.                  Retainer compensation:                  The built-in X-Y table retainer of the sewing machine may shift out of position after a prolonged use.                  In this case, the shape of a sewing pattern will be deformed or the origin retrieval failure will be caused.                  In order to prevent the aforementioned troubles, the position of the retainer can be forcibly corrected after pressing the  switch for the first time after turning ON the power to the machine. This performance is called "retainer compensation performance."</p> <p><b>[Note]</b>                  Be sure to make the machine perform the retainer compensation unless a special performance is required.</p>
---	--



1	<p>Retainer compensation is effective (standard set value)</p>
---	--

Set value	<p><b>[Description]</b>                  Retainer compensation performance is rendered effective.                  The machine performs the retainer compensation only when the  switch is pressed once after turning ON the power to the machine. However, when the  switch is pressed for the second time and beyond, the machine will not perform the retainer compensation.</p> <p>① Automatic retainer compensation performance                  When the  is pressed for the first time after turning ON the power to the machine. The feeding frame comes down and the feed moves limit-to-limit within its travel range. (After that, the feed stops at the sewing start point or the 2nd origin and the feeding frame rests in the highest position of its stroke.)</p> <p>* Even when you press the  for the 2nd time and beyond, the retainer compensation is not performed.</p> <p>② To manually perform retainer compensation                  Turn OFF the power to the machine. Gradually move feed ❶ back and forth and right and left until the respective travel limits are reached. (Once a day)</p>
-----------	---

**[Caution]**  
 If a special-purpose feeding frame is installed on your machine, the needle may break through the automatic retainer compensation performance. So, be sure to correct the retainer manually. To do this, carefully check the location of the needle.

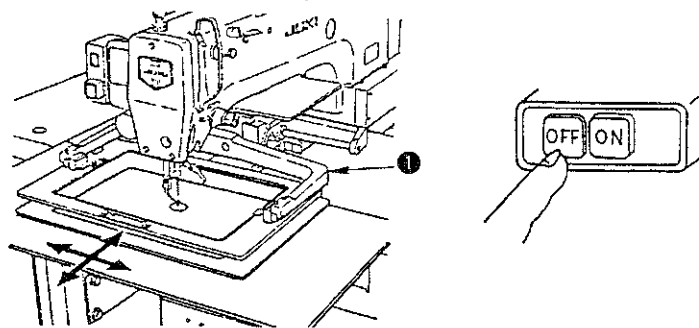

1) Operation setting		(Level 1)
Function No. 6	Returning route to the sewing start point	
Item: 1	When the sewing machine completes sewing	
Set value	0	The machine does not retrieve the mechanical origin. (Standard set value)
		[Description] The mechanical origin retrieval performance is not carried out.
Set value	1	The machine retrieves the mechanical origin.
		[Description] After the completion of sewing (thread trimming), it is possible to move the machine to the sewing start point (or the 2nd origin) by way of the mechanical origin.  <Example> <div style="text-align: center;"> </div>
Item: 2	When a travel limit error occurs.	
Set value	0	The machine does not retrieve the mechanical origin.
		[Description] The mechanical origin retrieval performance is not carried out.
Set value	1	The machine retrieves the mechanical origin. (Standard set value)
		[Description] When a travel limit error has occurred during sewing, the machine retrieves the origin, then moves to the sewing start point (or 2nd origin).

1) Operation setting		(Level 2)
Function No. 7	Returning route from a midpoint in sewing	
Item: 1	Mode setting	
Set value	0	Origin is retrieved along the data on the returning route stored in the system ROM. (Standard set value)
		<p>[Description]</p> <p>For a standard sewing pattern, the machine returns to the sewing start point taking the shortest route. For an inversion pattern, the machine returns to the start point while avoiding the crank of inverting intermediate presser.</p>
	1	The machine performs mechanical origin retrieval.
		<p>[Description]</p> <p>The machine retrieves the origin from some midpoint in sewing (temporary stop at a midpoint in sewing pattern, thread breakage detection, etc.) and returns to the sewing start point.</p> <p>&lt;Example&gt;</p>
2 ~	Special type of origin retrieving route	
	<p>[Description]</p> <p>In case where a special-purpose feeding frame or the like is used with you sewing machine, the machine is allowed to return to the origin taking a special route by inputting data on the route in the system ROM.</p> <p>[Caution]</p> <p>If you want to use a special route, it is necessary to change the system ROM.</p>	

1) Operation setting		(Level 2)
Function No. 8	Mechanical origin compensation	
Item: 1	X axis mechanical origin compensation	
Set value	-99 ~ +99	X axis mechanical origin compensation value setting (Standard set value 0)
		<p>[Description] The X axis mechanical origin can be corrected artificially by the amount specified for this item.</p> <p>&lt;Example&gt; When a feeding frame and sewing pattern that have been prepared using the other sewing machine, this function corrects a mechanical error.</p>
Item: 2	Y axis mechanical origin compensation	
	-99 ~ +99	Y axis mechanical origin compensation value setting (Standard set value 0)
		<p>[Description] The Y axis mechanical origin can be corrected artificially by the amount specified for this item.</p>

2) Processing function setting		(Level 1)
Function No. 13	Enlargement/reduction	
Item: 1 Pattern enlargement/reduction mode setting		
Set value	0	Pattern enlargement/reduction mode is prohibited.  [Description] Pattern enlargement/reduction is prohibited. The machine is allowed only to sew a sewing pattern according to the original size of the pattern data stored on a floppy disk.
	1	A scale can be set in 1% steps. (Standard setting)  [Description] The XY scale can be set in 1% steps. Data setting range: 1 to 400%  <Example of indication>  <div style="border: 1px solid black; display: inline-block; padding: 2px;">             1   0   0           </div>
	2	A scale can be set in 0.1% steps.  [Description] Set this item to 2 when you want to precisely specify a XY scale. Data setting range: 0 to 400.0%  <Example of indication>  <div style="border: 1px solid black; display: inline-block; padding: 2px;">             0   0.   0           </div>  [Note] In this indication method, the hundreds digit is not shown on the Pattern No. LED. So, be careful.

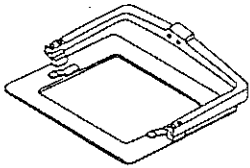
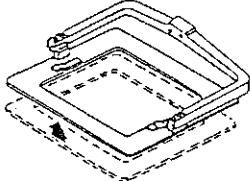
3) Command control		(Level 1)
Function No. 21	Cycle stitching	
Item: 1 Performance of the feeding frame		
Set value	0	The feeding frame is held in the lowest position to secure the workpiece on the machine. (The feeding frame cannot be operated using the pedal switch.)
		[Description] If a temporary stop command has been entered in the sewing pattern used, the feeding frame will not go up even when the sewing machine stops.
	1	The feeding frame is held in the lowest position to secure the workpiece on the machine. (The feeding frame can be released from the aforementioned position by operating the pedal switch.) (Standard set value)
		[Description] If a temporary stop command has been entered in the sewing pattern used, the feeding frame can be raised by operating the feeding frame pedal switch after the sewing machine stops. * Cycle sewing means to sew several sewing processes (cycles) continuously. The feeding frame goes up to allow you to change the workpiece if you have entered a temporary stop command at the desired point in a pattern so as to divide the pattern at that point.
		
	2	The feeding frame can be released from the lowest position. (The feeding frame can be lowered to secure the workpiece on the machine by operating the pedal switch.)
		[Description] If a temporary stop command has been entered in the sewing pattern used, the machine temporarily stops at that point and raises the feeding frame. Then, the feeding frame can be lowered by operating the pedal switch.
		
		[Caution] When the cycle sewing function is ON, take the below-stated precautions.  When the Forward or Backward key is pressed, the feed halts at the preset temporary stop position where the feeding frame can be raised or lowered using the feeding frame switch. If you want to continue to move the feed forward or backward, lower the feeding frame and re-start the operation.  The Return to Origin switch is used to return the machine to the start point of the first cycle in a sewing pattern. If you want to return the machine to the start of the current cycle, use the Backward key.  The Counter on the display counts the bobbin thread at the completion of a sewing pattern. If three cycles are input in a pattern, the Counter counts after the completion of the three cycles.  The Set Ready switch is rendered ineffective while a sewing pattern (between cycles) even if the feeding frame goes up. Press the Set Ready switch after pressing the Return to Origin switch or after the completion of the pattern.

3) Command control		(Level 2)
Function No. 22	Thread trimming command	
Item: 1	Thread trimming command switch	
Set value	0	Thread trimming command is ineffective.
		<p>[Description] A thread trimming command contained in sewing data is rendered ineffective.</p> <p>&lt;Example&gt; When a thick thread is used, an extra load is likely to be applied to the sewing machine mechanisms at the time of thread trimming causing the mechanism to be damaged. In this case, set item 1 to 0.</p>
	1	Thread trimming command is effective. (Standard set value)
		<p>[Description] The thread trimming command contained in sewing data is rendered effective.</p>

4) Operation system control		(Level 1)
Function No. 30		Bobbin thread counter
Item: 1 Operation mode setting		
Set value	0	UP counter (loop) (Standard set value)
		<p>[Description]</p> <p>The bobbin thread counter operates as an adding counter. When one cycle stitching completes, the value shown on the bobbin thread counter increases by 1 count. The counter counts the bobbin thread from 000 to 999. Press the <input type="button" value="Reset (select)"/> switch, and the value on the bobbin thread counter will be reset to 000.</p>
	1	DOWN counter (loop)
		<p>[Description]</p> <p>The bobbin thread counter operates as a subtracting counter. When one cycle stitching completes, the value shown on the bobbin thread counter decreases by 1 count. The counter counts the bobbin thread from 999 to 000. When 000 is reached, the counter will return to 999. Press the <input type="button" value="Reset (select)"/> switch, and the value on the bobbin thread counter will be reset to 999.</p>
	2	UP counter (The counter stops when the predetermined value is reached.)
		<p>[Description]</p> <p>The bobbin thread counter operates as an adding counter. Specify the number of times of bobbin thread counting using the <input type="button" value="Counter (set)"/> switch and numeric key, then press the <input type="button" value="Counter (set)"/> switch, and the Counter LED will flash on and off to allow the operator to check the specified value. Press the <input type="button" value="Counter (set)"/> switch, and "000" will be shown on the Counter LED. Now, the sewing machine is ready for sewing. Then, every time the sewing machine completes one cycle stitching, the value shown on the Counter LED will increase until the specified value is reached. When the specified value is reached, the value shown on the LED will flash on and off. Now, the sewing machine is incapable of continuing sewing any further.</p>
	3	DOWN counter (The counter stops when 0 is reached.)
		<p>[Description]</p> <p>The counter subtracts from the specified value until 000 is reached. When 000 is reached, the sewing machine stops. Specify the number of times of bobbin thread counting using the <input type="button" value="Counter (set)"/> switch, and the bobbin thread counter will subtract one from the specified value every time the sewing machine completes a cycle stitching. When "000" is reached, the Counter LED will flash on and off. Now, the sewing machine is incapable of continuing sewing any further. Press the <input type="button" value="Counter (set)"/> switch, and the bobbin thread counter will be reset to enable the sewing machine to start sewing. Even when the bobbin thread counter indicates a value other than "000," you can reset the value to the specified one using the <input type="button" value="Counter (set)"/> switch.</p>



4) Operation system control		(Level 1)
Function No. 31	Floppy disk data reading operation	
Item: 1 Selection of function		
Set value	0	Data is read from floppy disk only under the standby state (Standard set value)
		<p>[Description]</p> <p>Only when the machine is in the standby state (the READY indicator lamp goes out), the machine reads pattern data from the floppy disk by specifying the "  Pattern No.  ."</p>
Set value	1	Sewing state. Data can be read under the sewing state as well as the standby state.
		<p>[Description]</p> <p>Regardless of the state of the sewing machine, i.e., the standby state or the sewing state, pattern data can be changed.</p> <p>Changed data is read by specifying the "  ."</p>
Item: 2 Data reading mode setting		
Set value	0	Selected reading (Standard set value)
		<p>[Description]</p> <p>The machine does not read data from the floppy disk unless data on the pattern No. X/Y scale and the setting of the Scale setting switch (INC/DEC of the number of stitches) have been changed.</p>
Set value	1	Constant data reading
		<p>[Description]</p> <p>Pattern data is read from the floppy disk regardless of the pattern No. specified, XY scale specified and the setting of INC/DEC of the number of stitches setting switch.</p> <p>&lt;Example&gt;</p> <p>Use this function when performing sewing without using backup data.</p>

4) Operation system control		(Level 2)
Function No. 33	Automatic pattern reading from floppy disk	
Item: 1	Mode setting	
Set value	0	Continuous reading is ineffective (Standard set value)
		<p>[Description]</p> <p>The continuous pattern reading function is inoperative.</p>
	1	Continuous reading is effective
		<p>[Description]</p> <p>After the completion of sewing, the subsequent pattern data is read from the floppy disk. If the pattern numbers are not consecutive, the machine will enter the standby state to allow a pattern No. to be selected.</p> <p>[Operating procedure]</p> <p>After specifying 1 for the set value, press the <span style="border: 1px solid black; padding: 2px;">Backward</span> switch. Then, the error number display shows <span style="border: 1px solid black; padding: 2px;">H</span> to enable continuous pattern reading. If <span style="border: 1px solid black; padding: 2px;">H</span> is not shown on the Error Number display, the machine will perform the normal operation.</p> <p>&lt;Example&gt;</p> <p>Pattern Nos. will be as <span style="border: 1px solid black; padding: 2px;">1</span> → <span style="border: 1px solid black; padding: 2px;">2</span> → <span style="border: 1px solid black; padding: 2px;">3</span> → <span style="border: 1px solid black; padding: 2px;">*</span> → <span style="border: 1px solid black; padding: 2px;">5</span> → <span style="border: 1px solid black; padding: 2px;">6</span>.</p> <p style="margin-left: 150px;">↑</p> <p>Temporary stop state (READY indicator lamp goes out.)</p> <p>When "5" is specified, the machine proceeds to the subsequent operation.</p>

4) Operation system control		(Level 2)
Function No. 35	Idling operation	
Item: 1	Speed changing	
Set value	0	Constant speed (Standard set value)
		[Description] The machine runs idle at a constant speed at all times.
Set value	1	2-step speed
		[Description] While the machine performs jumping of sewing data, the jump speed can be increased by turning ON the Start switch.

4) Operation system control		(Level 1)
Function No. 36	Selection of thread trimming after turning ON the temporary stop switch.	
Item: 1	Thread trimming setting	
Set value	0	Thread trimmer automatically actuates.
		[Description] When the temporary stop switch is pressed, the sewing machine temporarily stops and the thread trimmer actuates.
	1	Thread trimmer is manually actuated. (Needle threading switch is used.) (Standard set value)
		[Description] When the temporary stop switch is pressed, the sewing machine stops and error No. "5" will flash on and off on the operation panel. In this state, the thread trimmer is actuated by turning ON then OFF the needle threading switch.
	2	Thread trimmer is manually actuated. (Temporary stop switch is used.)
		[Description] When the temporary stop switch is pressed, the sewing machine stops and error No. "5" will flash on and off on the operation panel. In this state, the thread trimmer is actuated by pressing the temporary stop switch again. The thread trimmer can also be actuated by operating the needle threading switch.

5) Mechanism control		(Level 1)
Function No. 40	Selection of the sewing speed	
Item: 1 Acceleration at the start of sewing		
Set value	0 ~ 4	Selection of the acceleration at the sewing start (depends on the setting of item 2 of function No. 1)
		<p>[Description]</p> <p>The start-up speed of the sewing speed is specified. It can be set to one of the six different stages. (Set value 1 is excluded.)</p> <p>Set value 0: The standard start-up speed. (Standard set value)</p> <p>Set value 1: Set value for embroidering (In this case, the start-up speed can be set to one of eight different stages.)</p> <p>Set value 2: High speed mode</p> <p>Set value 3: Medium speed mode 1</p> <p>Set value 4: Medium speed mode 2</p>
Item: 2 Sewing speed adapting to the material thickness		
Set value	0 ~ 3	Sewing speed adapting to the material thickness
		<p>[Description]</p> <p>When sewing a heavy-weight material, the max. sewing speed can be limited to ensure a sufficient length of time to allow the material to be fed after the needle has come off the material.</p> <p>Set value 0: 2,000 s.p.m. Light-weight material</p> <p>Set value 1: 1,600 s.p.m.</p> <p>Set value 2: 1,300 s.p.m.</p> <p>Set value 3: 1,000 s.p.m. Extra heavy-weight material</p> 

5) Mechanism control		(Level 1)
Function No. 41	Feed control	
Item: 1 Selection of the feed timing		
Set value	0 ~ 9	Selection of the feed start timing (Standard set value 0)
		<p>[Description]</p> <p>The feed start timing can be advanced by 0 to 9 pulses so as to adapt to the material thickness.</p> <p>9: Advances ←————→ 0: Retards (Standard value: 0) (Thick materials) (Thin materials)</p> <p>[Note]</p> <p>When the max. sewing speed is set to 2,000 s.p.m., the feed start timing setting does not affect the max. sewing speed. So, when you operate your machine with the max. sewing speed set at 2,000 s.p.m., set the feed start timing at the standard set value.</p>

5) Mechanism control		(Level 1)
Function No. 42	Thread trimmer prohibition	
Item: 1 Designation of thread trimmer prohibition		
Set value	0	Thread trimmer is ineffective.  [Description] Thread trimming is prohibited under any condition.  <Example> When a thick thread is used, an extra load is likely to be applied to the sewing machine mechanisms at the time of thread trimming causing the mechanism to be damaged.
	1	Thread trimmer is effective. (Standard set value 0)  [Description] All the functions related to the thread trimmer are rendered effective. The thread trimmer operates under the operation mode in accordance with the set values of Function Nos. 22 and 36.

5) Mechanism control		(Level 1)
Function No. 43		Feeding frame control
Item: 1 Operation sequence setting		
Set value	0 ~ 31	Selection of the feeding frame (Standard set value depends on the setting of item 2 of function No. 1.)
		[Description] Refer to "(6-1-7) Feeding frame control."
Item: 2 Selection of the state of feeding frame at the sewing end		
Set value	0	The machine returns to the sewing start, then the feeding frame goes up. (Standard set value)
		[Description] After the completion of sewing, the sewing machine travels to the sewing start point, lifts the feeding frame and waits for the start of next sewing.
	1	The machine returns to the sewing start and stops with the feeding frame lowered.
		[Description] After the completion of sewing, the sewing machine travels to the sewing start point and waits for the start of next sewing with the feeding frame lowered. At this time, the feeding frame can be raised with the Feeding frame switch. [Caution] The machine cannot be re-started unless the feeding frame is raised and lowered once.
	2	The feeding frame goes up to its intermediate stop position while the sewing machine returns to the sewing start.
		[Description] The feeding frame goes up to the first step of the double-stepped stroke during jump from the sewing end. Then the feeding frame is held raised until the machine reaches the sewing start.
	3	The feeding frame goes up to its intermediate stop position while the sewing machine returns to the sewing start.
		[Description] The feeding frame goes up to the second step of the double-stepped stroke during jump from the sewing end. Then the feeding frame is held raised until the machine reaches the sewing start.
Item: 3 Selection of the constant-lowering of the feeding frame		
Set value	0	Normal control (Standard set value)
		[Description] The feeding frame can be raised/lowered by operating the Feeding frame switch. The feeding frame operates under the operation mode in accordance with the set values of items 1 and 2.
	1	Constant-lowering of the feeding frame during sewing
		[Description] As long as the READY indicator lamp is ON, the feeding frame is always held lowered. <Example> This operation mode is used when sewing a label or the like that is placed inside the feeding frame.

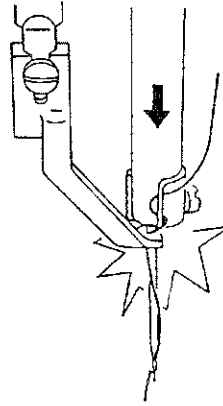
5) Mechanism control		(Level 1)
Function No. 44		Intermediate presser control
Item: 1 Intermediate presser control		
Set value	0	Intermediate presser prohibition (Standard set value for the CST and CHT types of sewing machines)
		<p>[Description] The intermediate presser is made inoperative. The intermediate presser is always fixed at the highest position of its stroke.</p> <p>&lt;Example&gt; Make the intermediate presser prohibition effective when sewing an inverting sewing pattern or the intermediate presser is not required for sewing in terms of the structure of the feeding frame used.</p> <p>[Caution] If the "prohibition" is specified without removing the intermediate presser, the needle bar will come in contact with the intermediate presser resulting in breakage of those components.</p>
		
	1	Intermediate presser is operative. (Standard set value) Note that the CST and CHT types of sewing machines are excluded.
	<p>[Description] The intermediate presser comes down at the start of sewing.</p>	
	2	Intermediate presser is operative.
		<p>[Description] For the normal operation, the intermediate presser operates as in the case of set value (1). When the intermediate presser control is set to 2, the intermediate presser operates even when the sewing machine runs idle using the sewing machine ON/OFF switch.</p>
Item: 2 Operation timing setting		
Set value	0	Intermediate presser comes down at the time of start-up (Standard set value)
		<p>[Description] The intermediate presser is lowered immediately before the sewing machine starts to rotate after the start of sewing.</p>
	1	Intermediate presser operates when the feeding frame comes down.
		<p>[Description] The intermediate presser operates simultaneously with the lowering motion of the feeding frame. When the separately-driven feeding frame, which operates in several steps, is used, the intermediate presser is lowered simultaneously with the lowering motion of the feeding frame in the final step.</p>

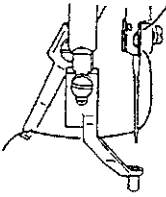
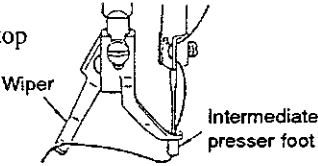
5) Mechanism control		(Level 1)
Function No. 45		Wiper operation
Item: 1 Wiper operation mode setting		
Set value	0	Wiper prohibition
		<p>[Description]</p> <p>The wiper is made inoperative.</p> <p>Under the state where the wiper is operative, the cycle time is slightly lengthened since the response time required to operate the wiper is taken into account. If you want to shorten the cycle time when the wiper is not required for the current operation, use this mode.</p> <p>[Caution]</p> <p><b>For the magnet-driven wiper, priority is given to the switch on the machine head.</b></p>
	1	Wiper is operative. (Standard set value)
		<p>[Description]</p> <p>The magnet type wiper is made operative.</p> <p>A signal which matches the timing for actuating the magnetic type wiper is output.</p> <p>For the wiper operation timing, the wiper operates in accordance with the set value of item (2).</p> <p>[Note]</p> <p><b>The switch mounted on the machine head that is used to set the wiper operation is given priority.</b></p>
	2	Wiper is operative.
		<p>[Description]</p> <p>The pneumatic type wiper is made operative.</p> <p>A signal which matches the timing for actuating the pneumatic type wiper is output.</p> <p>For the wiper operation timing, the wiper operates in accordance with the set value of item (2).</p>
Item: 2 Wiper operation timing setting		
Set value	0	Wiper sweeps above the intermediate presser. (Standard set value) Note that the CST, CHT and CGL types of sewing machines are excluded.
		<p>[Description]</p> <p>The wiper sweeps above the intermediate presser.</p> <p>Use this mode when sewing a light-weight material.</p> <div style="text-align: right;">  <p>Material thickness: Up to 3mm</p> </div>
	1	Wiper sweeps below the intermediate presser. Standard set value for the CST, CHT and CGL types of sewing machines.
		<p>[Description]</p> <p>The wiper sweeps below the intermediate presser.</p> <p>Use this mode when sewing a heavy-weight material and the top end of the intermediate presser comes in contact with the material.</p> <p>Under this mode, the wiper sweeps below the intermediate presser after the intermediate presser has been raised.</p> <div style="text-align: right;">  <p>Material thickness: 3-5mm</p> </div>



5) Mechanism control		(Level 1)
Function No. 46	Thread clamp operation	
Item: 1	Thread clamp operation mode setting	
Set value	0	Thread clamp prohibition (Standard set value)
		[Description] The thread clamp is made inoperative.
Set value	1	Thread clamp is operative.
		[Description] For the operating timing of the thread clamp, the thread clamp operates in accordance with the set value of item 2.
Item: 2	Thread clamp operation timing setting	
Set value	1 ~ 15	Thread clamp swings above the intermediate presser. (Standard set value 1)
		[Description] The number of stitches to be sewn, from the state where the thread clamp retains the needle thread to the point at which it releases the thread, is specified. The data setting range is 1 to 15 (stitches) as counted from the point at which the main shaft starts to rotate.

5) Mechanism control		(Level 1)
Function No. 47	Selection of thread breakage detector	
Item: 1 Operation mode setting		
Set value	0	Thread breakage detector prohibition [Description] The thread breakage detecting function is rendered ineffective. [Note] Use the thread breakage detector prohibiting function to make the thread breakage detection ineffective when the needle thread tension is decreased by a large margin or when the thread breakage detector fails to work with consistency.
	1	Thread breakage detector is operative. (Standard setting) [Description] The thread breakage detector is rendered effective. It works to stops the sewing machine, in case of thread breakage, in accordance with the number of stitches specified for item 2.
Item: 2 Setting the number of stitches required to stop the machine (at the sewing start)		
Set value	1 ~ 15	Setting the number of stitches required to stop the machine at the sewing start (Standard set value 8 stitches)
		[Description] The number of stitches required to stop the sewing machine after the detection of thread breakage at the sewing start is specified.
Item: 3 Setting the number of stitches required to stop the machine (during normal operation)		
Set value	1 ~ 15	Setting the number of stitches required to stop the machine during normal operation (Standard set value 3 stitches)
		[Description] The number of stitches required to stop the sewing machine after the detection of thread breakage during normal operation is specified.

5) Mechanism control		(Level 1)
Function No. 48		Selection of air pressure drop detecting function
Item: 1 Operation mode setting		
Set value	0	Air pressure drop detector prohibition
		[Description] The air pressure drop detecting function is rendered ineffective.
Set value	1	Air pressure drop detector is effective. (Standard set value)
		[Description] The air pressure drop detector is rendered effective. When the detector detects a drop of air pressure and error indication "A" will appear on the operation panel. If an excessive drop of operating air pressure is detected while the sewing machine is in operation, "A" will flash on and off on the Error Number display. Once the operating air pressure reaches the sufficient value, the machine will enter the "temporary stop" state. To reset, take the procedure same as that taken after pressing the "Temporary stop" switch.

5) Mechanism control		(Level 1)
Function No. 49		Selection of upper detecting function
Item: 1 Operation mode setting		
Set value	0	Upper detecting function prohibition
		[Description] The upper detecting function is rendered ineffective regardless of the state of the sewing machine, i.e., preparation state or sewing state. It is possible to move the feed with the needle point placed near the feeding frame (workpiece) when programming data using the input functions of the main unit or checking the shape of a sewing pattern. Note that the upper detector works when starting up the sewing machine (when the main shaft rotates). In this case, an error will result if the needle is not in the highest position of its stroke. Also note that the needle can be returned to the highest position of its stroke by operating the needle threading switch.
Set value	1	Upper detecting function is effective. (Standard set value)
		[Description] The upper detector is always rendered effective. If the needle is not in the highest position of its stroke when the feed operates and the main shaft rotates, error indication "3" will appear on the operation panel.

5) Mechanism control		(Level 2)
Function No. 51	Inverting mechanism control	
Item: 1	Control of the inverting mechanism control	
Set value	0	The inverting mechanism control is rendered ineffective. [Description] Even when an inversion pattern is used, the inverting mechanism control is not performed.
	1	The inverting mechanism control is rendered effective. (Standard set value) [Description] When an inversion pattern is used, the inverting clamp control is rendered effective.

5) Mechanism control		(Level 2)
Function No. 53	Tension controller No. 3 control	
Item: 1	Rendering the tension controller No. 3 control effective or ineffective.	
Set value	0	The tension controller No. 3 control is rendered ineffective. [Description] Even when the pattern data has a mark 2 data, the tension controller No. 3 control mechanism is rendered ineffective. Mark 2: The command which turns ON/OFF the signal of the tension controller No. 3. It can be input using a PGM-5A. Refer to the Instruction Manual for the PGM-5A for details.
	1	The tension controller No. 3 control is rendered effective. (Standard set value) [Description] The tension controller No. 3 control is rendered effective. The tension controller No. 3 is turned ON at a mark 2 data on the pattern data. When the next mark 2 data is reached, the tension controller No. 3 is turned OFF. In this way, the tension controller No. 3 control is, in repetition, turned ON at odd numbers of mark 2 data or OFF at even number of it.

5) Mechanism control		(Level 2)
Function No. 55	Buzzer control	
Item: 1 Rendering the sound of buzzer when accepting a key switch effective or ineffective		
Set value	0	The sound of buzzer is ineffective.  [Description] The buzzer does not sound when a key switch on the operation panel is pressed.
	1	The sound of buzzer is effective.  [Description] The buzzer sounds when a key switch on the operation panel is pressed.

5) Mechanism control		(Level 1)																										
Function No. 56	Selection of floppy disk data reading sequence																											
Item: 1 Operation mode setting																												
Set value	0 ~ 4	(Standard set value Mode 0) (AMS-215C priority mode)  [Description] A long time is required to read data from a floppy disk because of difference and interchangeability of the floppy disks applicable to the AMS Series. Use this function to minimize the length of time required to read data stored on a floppy disk.  [Data reading sequence] <ul style="list-style-type: none"> <li>① : Floppy disk for the AMS-215C</li> <li>② : Floppy disk for the AMS-B type</li> <li>③ : Floppy disk for the AMS-A type</li> <li>④ : } Normally disused.</li> <li>⑤ : }</li> </ul>																										
		<table border="1" style="margin-left: auto; margin-right: auto;"> <thead> <tr> <th rowspan="2">Set value</th> <th colspan="3">Data reading sequence</th> </tr> <tr> <th>1</th> <th>2</th> <th>3</th> </tr> </thead> <tbody> <tr> <td>0</td> <td>①</td> <td>②</td> <td>③</td> </tr> <tr> <td>1</td> <td>②</td> <td>①</td> <td>③</td> </tr> <tr> <td>2</td> <td>③</td> <td>①</td> <td>②</td> </tr> <tr> <td>3</td> <td>-</td> <td>-</td> <td>-</td> </tr> <tr> <td>4</td> <td>-</td> <td>-</td> <td>-</td> </tr> </tbody> </table>	Set value	Data reading sequence			1	2	3	0	①	②	③	1	②	①	③	2	③	①	②	3	-	-	-	4	-	-
Set value	Data reading sequence																											
	1	2	3																									
0	①	②	③																									
1	②	①	③																									
2	③	①	②																									
3	-	-	-																									
4	-	-	-																									
		[Note] Do not read data from the floppy disk for the AMS-215C, AMS-A or -B type model of sewing machine with the function set at 3 or 4.																										

6) Setting the delay time		(Level 2)
Function No. 81	Wiper sweeping action (magnet)	
Item: 1	The period of time during which the wiper (magnet) is energized and that required to reset the wiper are specified.	
Set value	0-999	Period of time during which the wiper is energized (Standard set value T1 = 50 ms)
		[Description] The length of time during which the wiper is in its ON state is specified.
Item: 2	The period of time required to reset the wiper (magnet) is specified.	
	0-999	The period of time required to reset the wiper (Standard set value T2 = 100 ms)
		[Description] The length of time required to allow the machine to start the next operation from the completion of sweeping action of the wiper can be specified. During the specified length of time, other mechanisms are inoperative.
<p>The diagram illustrates the timing sequence for the wiper sweeping action. It shows three signals over time: 'Wiper signal', 'Signal of other mechanisms', and 'Other mechanisms operate.'. The 'Wiper signal' starts at a low level, transitions to high for a duration labeled 'T1' (the 'ON' time), and then returns to low. A horizontal line with arrows at both ends, labeled 'Set value of item 1', spans the duration of T1. The 'Signal of other mechanisms' starts at a low level and remains low until the wiper signal returns to low. At that point, it transitions to high. A horizontal line with arrows at both ends, labeled 'T2' and 'Set value of item 2', spans the delay period between the wiper signal returning to low and the 'Signal of other mechanisms' transitioning to high. A callout box labeled 'Other mechanisms operate.' is connected to the high portion of the 'Signal of other mechanisms' line.</p>		

6) Setting the delay time		(Level 2)
Function No. 82	Wiper sweeping action (air)	
Item: 1	The period of time during which the wiper (air) is energized and that required to reset the wiper are specified.	
Set value	0-999	Period of time during which the wiper is energized (Standard set value $T1 = 100$ ms)
		<p>[Description]</p> <p>The length of time during which the wiper is in its ON state is specified.</p>
Item: 2	The period of time required to reset the wiper (air) is specified.	
	0-999	The period of time required to reset the wiper (Standard set value $T2 = 100$ ms)
		<p>[Description]</p> <p>The length of time required to allow the machine to start the next operation from the completion of sweeping action of the wiper can be specified. During the specified length of time, other mechanisms are inoperative.</p>
<p>The diagram illustrates the timing relationship between the wiper signal and other mechanisms. The wiper signal is a rectangular pulse with a duration labeled <math>T1</math>, which is also indicated as the 'Set value of item 1'. After the wiper signal returns to its baseline, there is a delay period labeled <math>T2</math>, which is the 'Set value of item 2'. During this <math>T2</math> period, the 'Signal of other mechanisms' is shown as a horizontal line that is inactive. Once the <math>T2</math> period ends, the signal becomes active, and a bracket indicates that 'Other mechanisms operate.'</p>		

6) Setting the delay time		(Level 2)
Function No. 84	Intermediate presser action timing	
Item: 1	Lowering the intermediate presser	
Set value	0-999	Setting the length of delay time after the intermediate presser has come down (ON timing) (Standard set value 50 ms)
		[Description] If the sewing machine starts running immediately after the intermediate presser has operated, the intermediate presser is likely to interfere with the needle bar since the intermediate presser has a mechanical delay. To prevent this, the sewing machine starts to run after the length of time specified for this item has passed.
Item: 2	Raising the intermediate presser	
Set value	0-999	Setting the length of delay time after the intermediate presser has gone up (OFF timing) (Standard set value 150 ms)
		[Description] If the wiper actuates when the intermediate presser has not gone up to the highest position, the former may interfere with the latter. To prevent this, the wiper actuates after the length of time specified for this item has passed. During this period of time, neither the wiper nor the feed actuate.



### 6-1-7. Feeding frame control



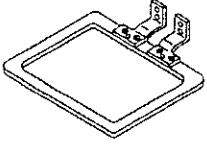
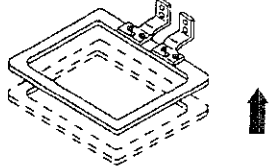
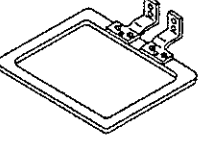
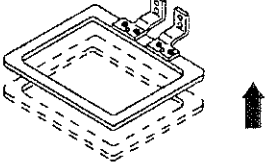
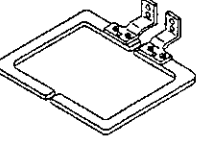
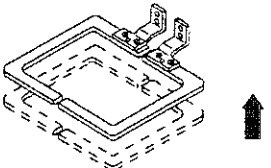
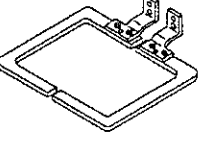
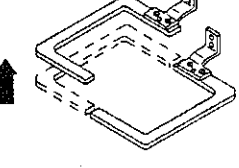



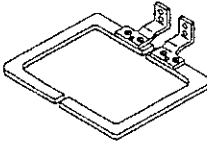
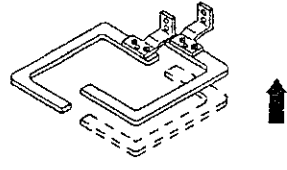
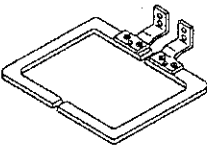
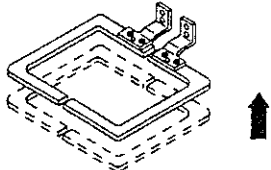
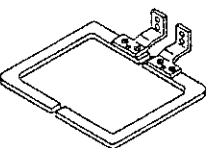
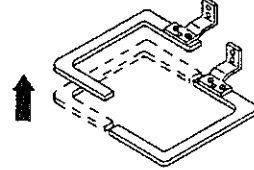
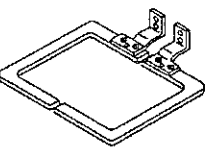
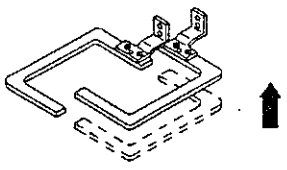

Items 1: Setting the operation sequence

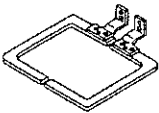
Set value	Classification	Double-stepped stroke	"At the time of cycle sewing"
0	 Monolithic feeding frame	×	 The feeding frame stops in the highest position of its stroke.
1	 Monolithic feeding frame	○	 The feeding frame stops in the highest position of its stroke.
2	 Separately-driven feeding frame	×	 The feeding frame stops in the highest position of its stroke.
3	 Separately-driven feeding frame	×	 The feeding frame stops only with its left portion raised.

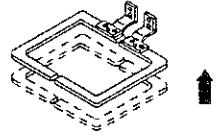
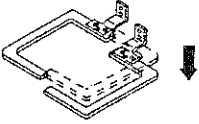
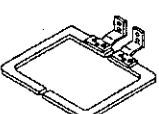
**[Caution]**

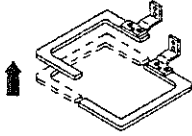
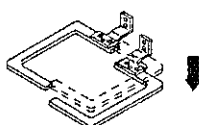
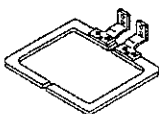
In the "Double-stepped stroke" column, "○" indicates that the double-stepped stroke function can be used or "×" means that it cannot be used. The performance of the feeding frame equipped with an inverting device is same as that of the separately-driven feeding frame.

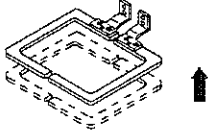
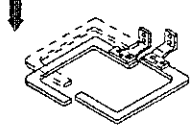
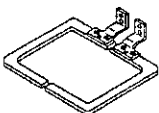
Set value	Classification	Double-stepped stroke	*At the time of cycle sewing
4	 <p>Separately-driven feeding frame</p>	×	 <p>The feeding frame stops only with its right portion raised.</p>
5	 <p>Separately-driven feeding frame</p>	○	 <p>The feeding frame stops in the highest position of its stroke.</p>
6	 <p>Separately-driven feeding frame</p>	○	 <p>The feeding frame stops only with its left portion raised.</p>
7	 <p>Separately-driven feeding frame</p>	○	 <p>The feeding frame stops only with its right portion raised.</p>

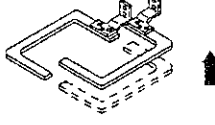
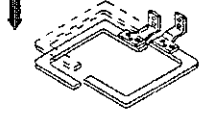
Set value	Classification	Double-stepped stroke	*1At the time of cycle sewing	*2Feeding frame operation controlled by the foot pedal
8	 Separately-driven feeding frame		 The feeding frame stops in the highest position of its stroke.	 The right portion of the feeding frame comes down first.
9	 Separately-driven feeding frame		 The feeding frame stops only with its left portion raised.	 The right portion of the feeding frame comes down first.
10	 Separately-driven feeding frame		 The feeding frame stops in the highest position of its stroke.	 The left portion of the feeding frame comes down first.
11	 Separately-driven feeding frame		 The feeding frame stops only with its right portion raised.	 The left portion of the feeding frame comes down first.

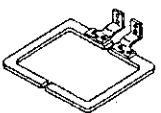
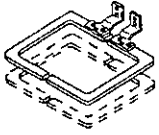
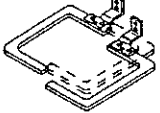
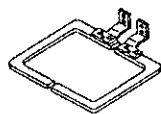
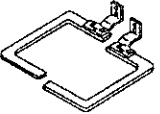
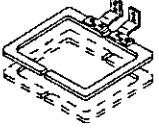
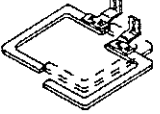
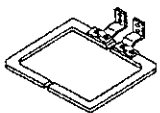
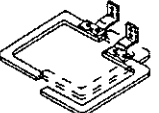
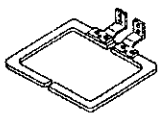
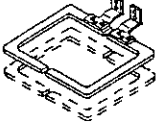
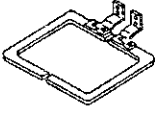
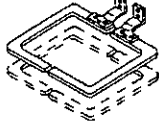
Set value	Classification	Double-stepped stroke	*1At the time of cycle sewing	*2Feeding frame operation controlled by the foot pedal
12	 Separately-driven feeding frame	×	 The feeding frame stops in the highest position of its stroke.	 The right portion of the feeding frame comes down first.
13	 Separately-driven feeding frame		 The feeding frame latches at the intermediate stop position	 The right portion of the feeding frame comes down first.
14		○		 The right portion of the feeding frame comes down first.
15		×	 The feeding frame stops in the highest position of its stroke.	
16		○	 The feeding frame stops in the highest position of its stroke.	

**[Caution]**

1. For the feeding frames marked with "1," it is possible to select either close or open of the feeding frame, depending on the setting of item 1 of the memory switch 21, when it stops in the intermediate stop position.
2. For the feeding frames marked with "2," it is possible to select either close or open of the feeding frame, depending on the setting of item 2 of the memory switch 43, when the sewing completes.

## 6-2. Error messages

The error number or alphabets will be shown on the error number display of the operation panel to indicate the condition of the machine.

Error No.	Indicator lamp	Error description	Action to be taken
1	ON	Comes on if a malfunction has resulted in a data read-out error.	Press the Set Ready Key to read out the data again.
	ON The pattern No. indicator lamp flashes on and off	Starts when there is no data for the relevant number.	Set the correct Pattern No.
	Flash	A floppy disk is no inserted.	Insert a floppy disk.
2	ON	Comes on if the stitch length exceeds 12.7 mm over the computable range in an attempt to enlarge a pattern based on the number of stitches.	Correctly reset the X- and/on Y-scale.
3	ON	Comes on if the needle is not in its highest position.	Turn the handwheel until error No. "3" disappears. Or turn ON/OFF the Needle Threading switch to raise the needle to its highest position.
4	ON	Comes on if the maximum sewing area (180mm x 110mm) is exceeded.	During a sewing cycle: Press the Return to Origin key. While setting the 2nd origin: Press the Jog key.
5	Flash	Starts when the temporary stop switch is turned ON.	Press the start switch to actuate the sewing machine again. Turn ON/OFF the Needle Threading switch, and the thread will be trimmed. (The lamp display changes from "Flash" to "ON".)
	ON	Comes on when only the feeding frame is moving. Comes on when the temporary stop switch is turned ON.	Turn ON the start switch after pressing the return to origin and the forward or backward switch.
6	ON	When large pattern data have been read or a complicated processing has been carried out resulting in shortage of memory.	If the error has occurred when combining sewing patterns, press the set ready switch or re-specify a scale.
7	ON	Comes on if a malfunction has caused the machine to lock, or if there has been a failure in the needle position detector.	Turn OFF the power switch. Replace the defective parts or eliminate the cause of the machine locking. Then turn ON the power switch.
8	ON	Comes on if a poor connection of a solenoid connector is detected.	Turn OFF the power switch, and check for the loose solenoid connection.
9	ON	Comes on if the needle thread is broken.	Re-thread the machine head, press the return to origin switch and the forward or backward switches to move the feeding frame backward. Then press the start switch.
0	Flash	Starts when trying to format a floppy disk with the write-protect tab in the open position (the disk cannot be formatted).	Move the write-protect tab so that it is in its closed position.
	ON	Comes on when trying to format a defective floppy disk.	Replace the floppy disk.
A	ON	Air pressure is low. Air is not supplied to the sewing machine. Connector of the junction cable for the air valve disconnects.	Turn OFF the power switch. Set the air pressure to 5~5.5 kgf/cm <sup>2</sup> (0.5~0.55 MPa). Connect the connector.
	(Flash)	(Air pressure has dropped during sewing.)	(Adjust the air pressure to the specified value and re-start the sewing machine.)
E	ON	Comes on when the sewing machine rotates in the reverse direction.	Turn OFF the power switch. Change the rotation direction of the motor.