

**SUPER HIGH SPEED STRAIGHT NEEDLE
OVERLOCK SEWING MACHINES**

PARTS LIST

MODEL OV-600

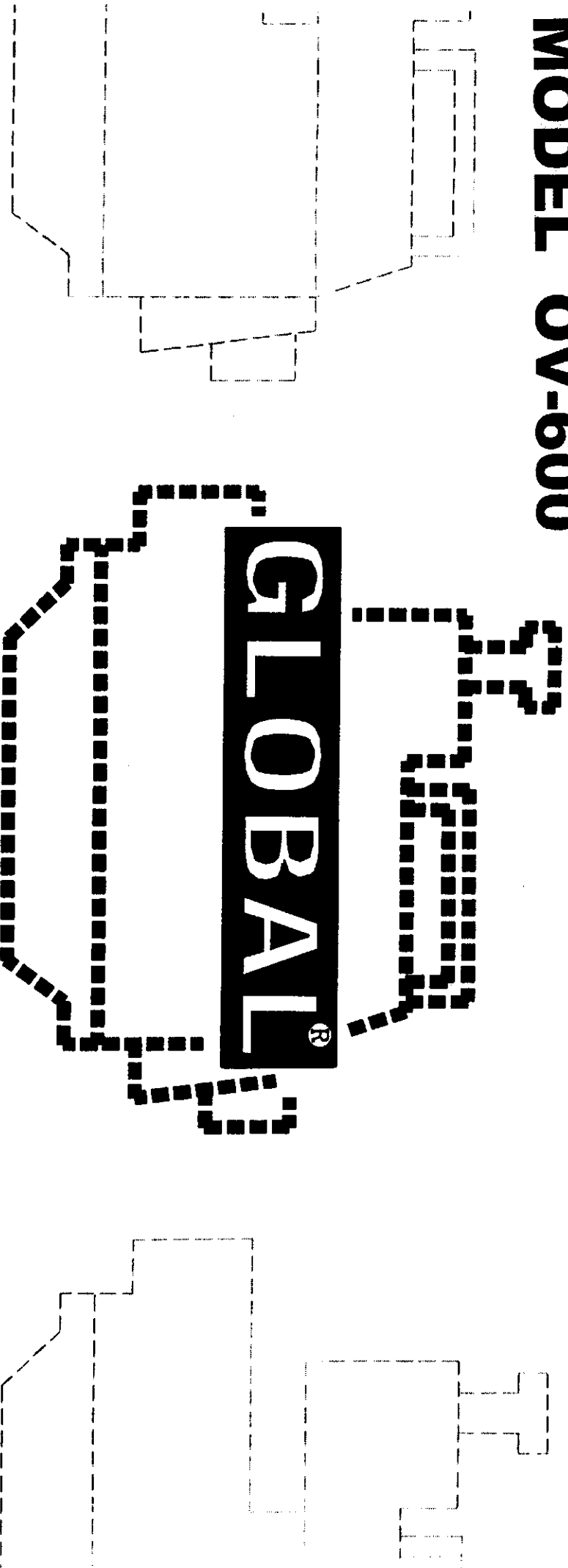

VER 1.0 2002.12
SH6302-G-02-12

CONTENTS

TABLE OF CONTENTS

	PAGE
1 FRAME COMPONENTS (1)-----	1
2 FRAME COMPONENTS (2)-----	2
3 CRANK SHAFT COMPONENTS-----	3
4 NEEDLE DRIVING SHAFT COMPONENTS-----	4
5 FEED MECHANISM COMPONENTS (1)-----	5
6 FEED MECHANISM COMPONENTS (2)-----	6
7 UPPER AND LOWER LOOPER COMPONENTS-----	7
8 CHAIN LOOPER COMPONENTS (FOR OV-616)-----	8
9 PRESSER FOOT COMPONENTS (1)-----	9
10 PRESSER FOOT COMPONENTS (2)-----	10
11 THREAD TENSION COMPONENTS-----	11
12 LOWER KNIFE COMPONENTS-----	12
13 UPPER KNIFE COMPONENTS-----	13
14 NEEDLE COOLING MECHANISM-----	14

15	LUBRICATION MECHANISM-----	15
16	THREAD STAND COMPONENTS-----	16
17	SEMI-SUNKEN TYPE TABLE COMPONENTS-----	17
18	FULLY-SUNKEN TYPE TABLE COMPONENTS S-----	18
19	FOR OV-616-633, OV-616-635 -----	19
20	OV-616-555 SPARE PARTS-----	20
21	ACCESSORIES-----	21
22	OV-636-558 SPARE PARTS-----	22
	APPENDIX 1-GAUGE SET LIST-----	APP.1
	(OV-604) (OV-614) (OV-616)	
	APPENDIX 2-THREAD GUIDE-----	APP.2
	(OV-604) (OV-614) (OV-616) (OV-643)	
	APPENDIX 3-DIMENSION FOR SEMI SUBMERGED MOUNTING	APP.3
	APPENDIX 3-DIMENSION FOR FULLY SUBMERGED MOUNTING	

(1) FRAME COMPONENTS

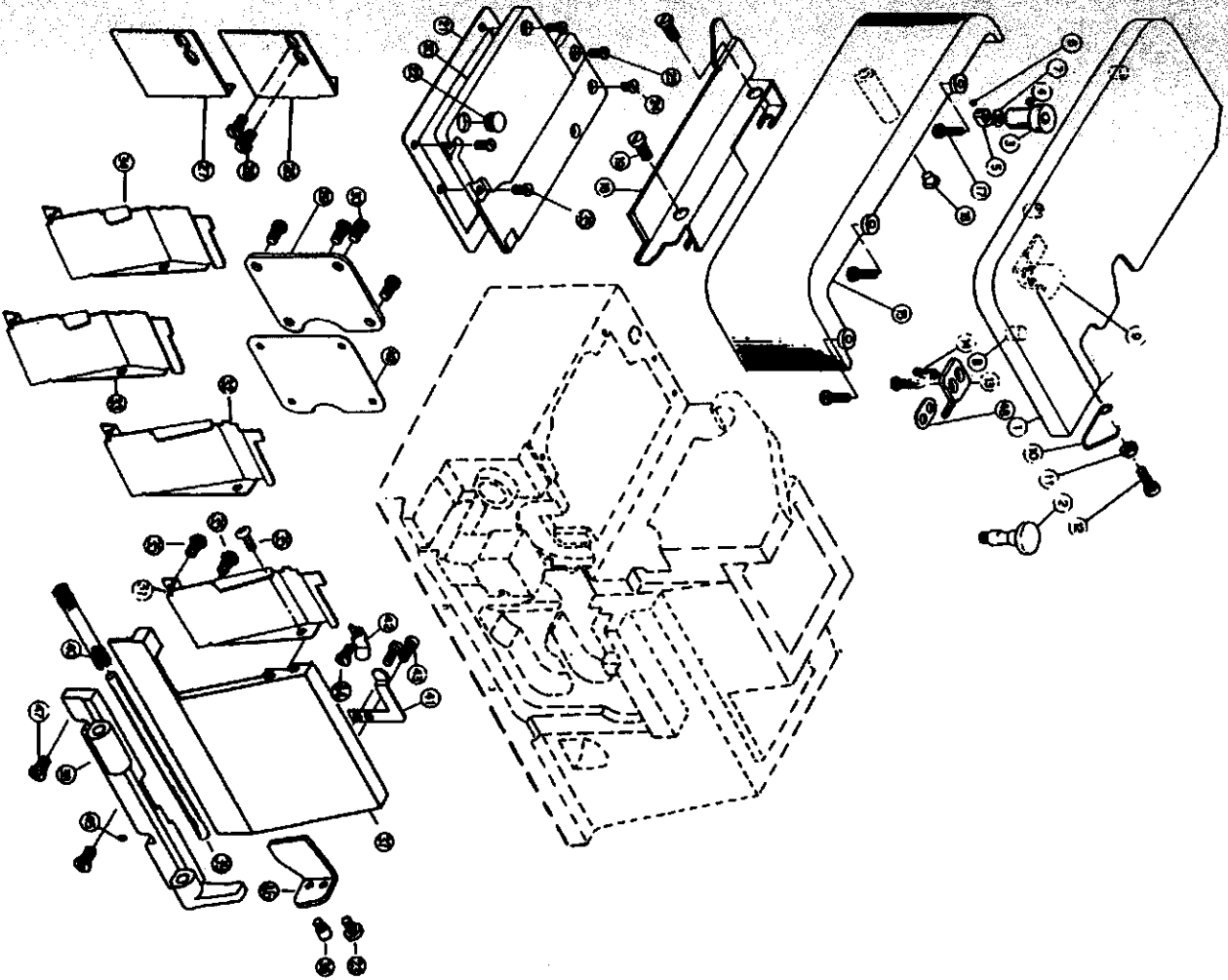

RefNo DESCRIPTION

PARTS NO.

QUANTITY

RefNo	DESCRIPTION	PARTS NO.	QUANTITY
1	Cloth plate asm	6030101C700	1
2	Cloth plate hinge stud	6030102B300	1
3	Eccentric bushing	6030103A500	1
4	Screw	SN44400A00E	1
5	Nut	6030105D300	1
6	Screw	SN32440300E	1
7	Waved washer	6030107D700	1
8	Collar	6030108A600	1
9	Stopper base	6030109C700	3
10	Spring	6030110A800	1
11	Nut	SA44400A07A	1
12	Screw	SB44401407A	1
13	Stopper	6030113B700	1
14	Screw	SC44400906M	2
15	Clothplate cover	6030115D600	1
16	Rubber plug	6030116A600	1
17	Screw	SC36401307D	3
18	Cloth plate side cover	6030118B700	1
19	Screw	SB48280808A	1
20	Feed mechanism cover	6030120C200	2
21	Gasket	6030121G700	1
22	Rubber plug	6030122A600	1
23	Screw	SB36400607A	1
24	Screw	SE36401107A	1
25	Screw	SC36401007D	3
.1,2,26	Chip guard cover left	R6030126B700	1
.3,4,27	Chip guard cover left	R6030127B700	1
28	Screw	SB44400608K	2
29	Cover	6030129B700	1
30	Screw	SC44400907D	4
.1,31	Chip guard cover	7030131B700	1
.2,32	Chip guard cover	7040132B700	1
.3,33	Chip guard cover	7050133B700	1
.4	Chip guard cover	7050134B700	1
35	Screw	SC36400707D	1
36	Screw	SB36400505M	4
37	Looper cover	6030137C200	1
38	Looper cover bracket	6030138C200	1
39	Looper cover hinge pin	6030139D300	1
40	Spring	6030140A800	1
41	Looper cover presser plate	6030141D700	1
42	Looper cover presser spring	6030142D700	1
43	Screw	SC36400605D	1
44	Screw	SC44400907D	2
45	Screw	SN44400A00E	1
46	Latch	6030146B700	1
47	Screw	SC44401208D	1
48	Washer	6030148B700	2
49	Gasket	6030149C700	1

- .1 For OV-604
- .2 For OV-614
- .3 For OV-616 - 3
- .4 For OV-616 - 5

(3) CRANK SHAFT COMPONENTS

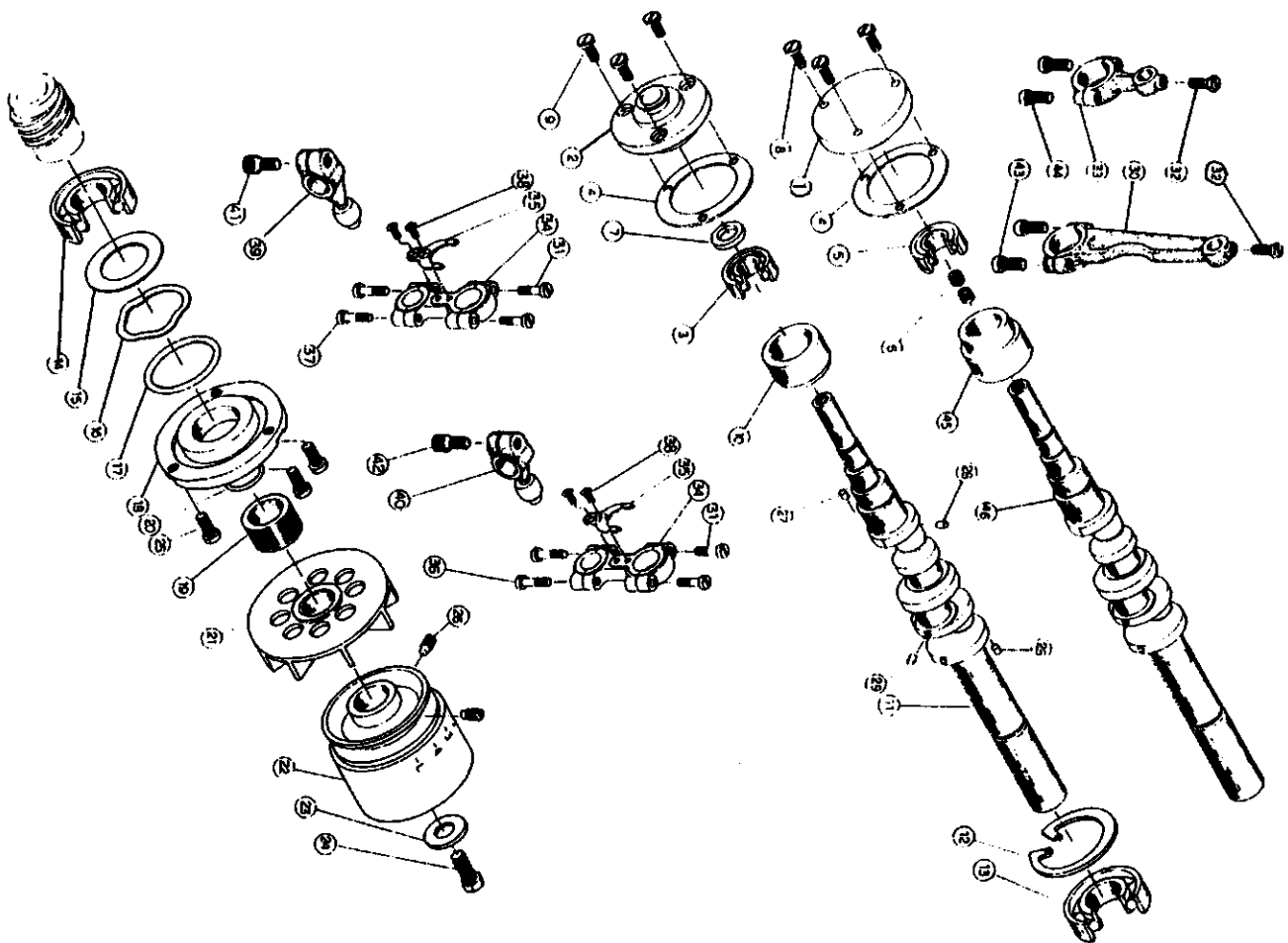

RefNo	DESCRIPTION	PARTS NO.	QUANTITY
1	Crankshaft bushing	6030301F300	1
2	Crankshaft bushing	6050302F300	1
2	Ball bearing	BB10260902	1
3	Ball bearing	6030304G700	1
4	Gasket	BB10260800	2
5	Ball bearing	SC60280700A	1
6	Screw	6050826A600	2
7	Oil seal	SC44401208D	1
8	Screw	SB44400807A	3
9	Screw	6050310B500	3
10	Crankshaft bushing	6050311A300	1
11	Crankshaft	6030312D700	1
12	Ball bearing retainer	BB17401200	1
13	Ball bearing	BB17401202	1
14	Ball bearing	6030315D700	1
15	Washer	6030318C200	1
16	Waved washer	6030316D700	1
17	Rubber ring	6030317A600	1
18	Thrust holder	6030318C200	1
19	Position lock ring	6030319C300	1
20	Oil seal	6030320A600	1
21	Fan	6030321C200	1
22	Hand wheel	6030322C200	1
23	Washer	6030323B700	1
24	Screw	SK60281510B	1
25	Screw	SC48281208D	3
26	Screw	SI60281000B	2
27	Plug	6030327H300	1
28	Plug	6030328H300	1
29	Plug	6030329H300	2
30	Needle bar connecting rod	6030330D100	1
31	Screw	MB04281507B	4
32	Screw	SK44400606A	2
33	Knife driving rod	6030333D100	1
34	Looper driving rod	6030334D100	1
35	Guide	6030335D300	2
36	Screw	MB04281507B	2
37	Screw	MB04281507B	2
38	Screw	MB03200505K	4
39	Crank	6030339A100	1
40	Crank	MM06301210A	1
41	Screw	MM06301210A	1
42	Screw	MM06301210A	1
43	Screw	MB04281507B	2
44	Screw	MB04281507B	2
45	Crankshaft bushing	6030345B500	1
46	Crankshaft	6030346A300	1

.1 For OV-604 · OV-614
 .2 For OV-616

(4) NEEDLE DRIVING SHAFT COMPONENTS

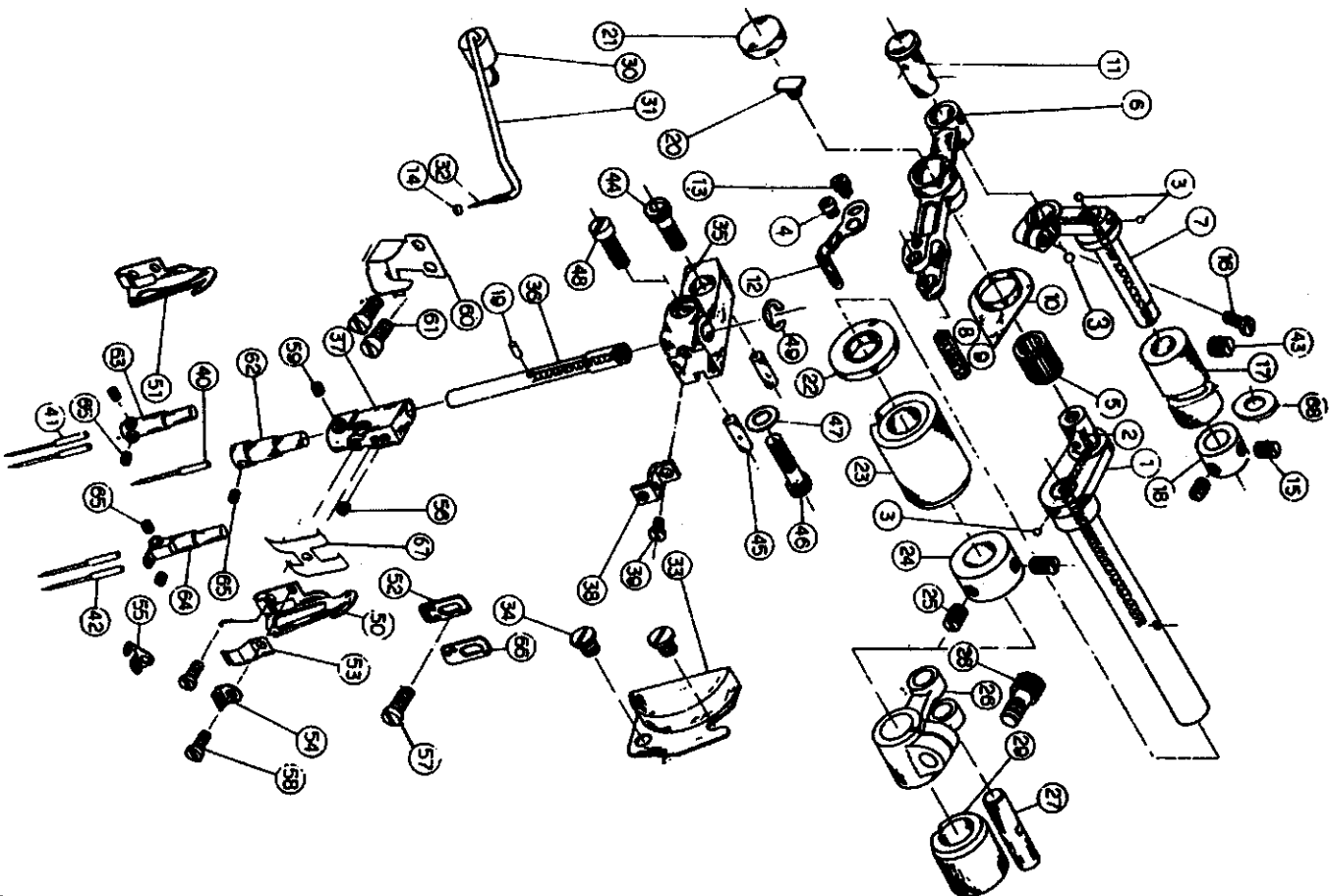

Ref.No	DESCRIPTION	PARTS NO.	QUANTITY
1	Needle driving shaft	6030M01A100	1
2	Oil wick	6030M03B300 6707	1
3	Pin	6030M03B300	4
4	Screw	SB2456M05A	1
5	Bushing	NB09121300	1
6	Needle driving lever	6030M06A100	1
7	Holder	6030M07A100	1
8	Crank pin	6030M08A300	1
9	Oil wick	6707	1
10	Oil shield	6030M10B0700	1
11	Crank pin	6030M11A300	1
12	Needle thread presser	6030M12D700	1
13	Screw	SB2456M05A	1
14	Pin	6030M27H300	2
15	Screw	SN4440M00E	1
16	Screw	SC3640100B02	1
17	Bushing	6030M17C300	1
18	Thread collar	6030M18D300	1
19	Oil wick	6030M19L700	1
20	Ball	6030M20D300	1
21	Cover	6030M21D700	1
22	Oil seal	6030M22A600	1
23	Bushing	6030M23C300	1
24	Thread collar	6030M24D300	1
25	Screw	SC563020500A	2
26	Forced crank	6030M26A100	1
27	Pin	6030M27A300	1
28	Screw	NM460751210A	1
29	Bushing	6030M29C300	1
30	Oil wick cover bushing	6030M30M600	1
31	Oil tube	6991	1
32	Oil wick	6706	1
33	Cover	6030M33B700	1
34	Screw	SC44400508D	2
35	Needle Bar Base	6030M35B200	1
36	Needle bar	6030M36A300	1
37	Needle clamp base	6030M37D100	1
38	Needle thread guide	6030M38B700	1
39	Screw	SB3640M06A	1
40	Needle	DC27YXX	1
41	Needle	DC27YXX	2
42	Needle	DC27YXX	2
43	Screw	SC60780700A	1
44	Screw	MM460102010A	1
45	Pin	STD4H	2
46	Screw	MM460102210A	1
47	Washer	6030J23B700	1
48	Screw	SB48281288A	1
49	Returner E	ER07	1
50	Needle thread take-up lever	6030M50D700	1
51	Needle thread take-up lever	6030M51D700	1
52	Needle thread guide	6030M52B700	1
53	Presser spring	6030M53N700	1
54	Needle thread guide	6030M54B700	1
55	Needle thread guide	6030M55B700	1
56	Screw	SC3640M06A	1
57	Screw	SB3640M06A	1
58	Screw	SE3244M05A	2
59	Screw	SN4440M00E	1
60	Oil reservoir arm	R6030M60B700	1
61	Screw	SB3640M06A	2
62	Needle clamp	NC063033	1
63	Needle clamp	NC06M022	1
64	Needle clamp	NC06S032	1
65	Screw	SH3244M0300A	5
66	Needle thread guide	6030M72B700	1
67	Needle clamp base cover	R6030M67	1
68	Needle clamp base cover	6030M67	1

.1 For OV-604 .3 For OV-616
 2 For OV-614 4 For OV-604-000

(5) FEED MECHANISM COMPONENTS

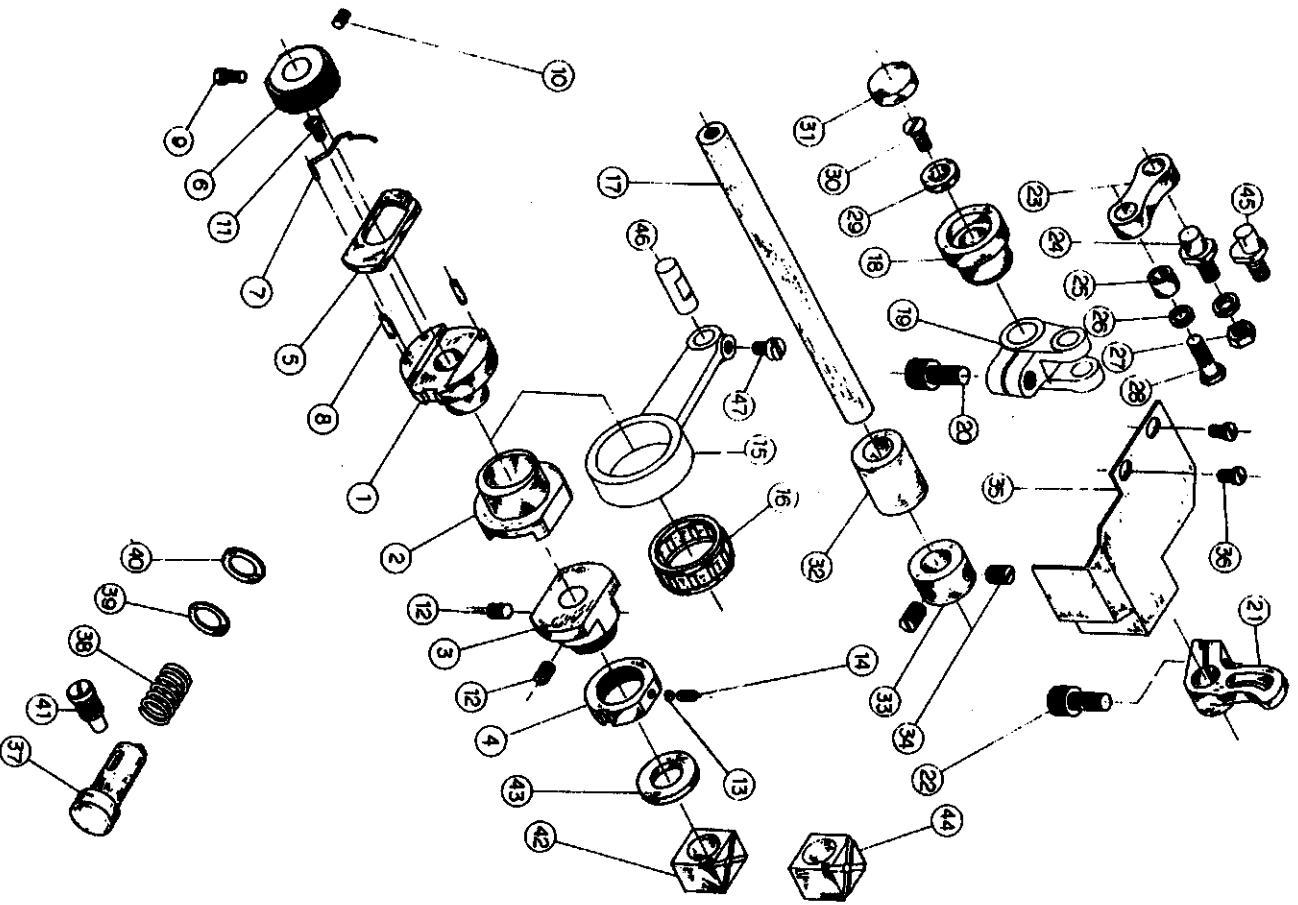

Ref.No DESCRIPTION

PARTS NO.

QUANTITY

Ref.No	DESCRIPTION	PARTS NO.	QUANTITY
1	Eccentric	6030501A300	1
2	Eccentric	6030502A300	1
3	Press ring	6030503A300	1
4	Nut	6030504B300	1
5	Ratchet pawl	6030505B700	1
6	Ratchet gear	6030506A300	1
7	Ratchet pawl spring	6030507A800	1
8	Spring pin	SP0308	2
9	Screw	SB444W706F	1
10	Screw	SN44400K00E	1
11	Screw	SB24566K4AB	1
12	Screw	SN44400K00E	2
13	Plug	6030513E700	1
14	Screw	SN32440300E	1
15	Crank rod	6030515A100	1
16	Bearing	NB22261000	1
17	Rocker Shaft	6030517A300	1
18	Rocker shaft bushing	6030518CG300	1
19	Crank	6030519A100	1
20	Screw	MM06301210A	1
21	Main feed rocker	6030521A100	1
22	Screw	MM60301210A	1
23	Main feed link	6030523 E200	1
24	Crank Pin	6030524A300	1
25	Collar	6030525A300	1
26	Washer	6030526B700	2
27	Nut	SA48320409B	1
28	Screw	SK48321207C	1
29	Washer	6030529B700	1
30	Screw	SE364K0806B	1
31	Rubber plug	6030531A600	1
32	Bushing	6030532G300	1
33	Thrust collar	6030533D300	1
34	Screw	SH56320500A	2
35	Cover	6030535B700	1
36	Screw	SC36400707D	2
37	Push button stud	6030537D300	1
38	Spring	6030538A800	1
39	Washer	6030539D700	1
40	Felt	6030540L700	1
41	Bolt	SB60281507D	1
42	Slide Block	6030542G300	1
43	Washer	6030543B700	1
44	Slide Block	6030544G300	1
45	Crank Pin	6030545A300	1
46	Crank Pin	6030546A300	1
47	Screw	SK44400606A	1

.1 For OV-604 - 614

.2 For OV-616

.3 For OV-604-059 - OV-614-249 - OV-616-559

OV-604-000 - OV-616-359PDX5

(6) FEED MECHANISM COMPONENTS

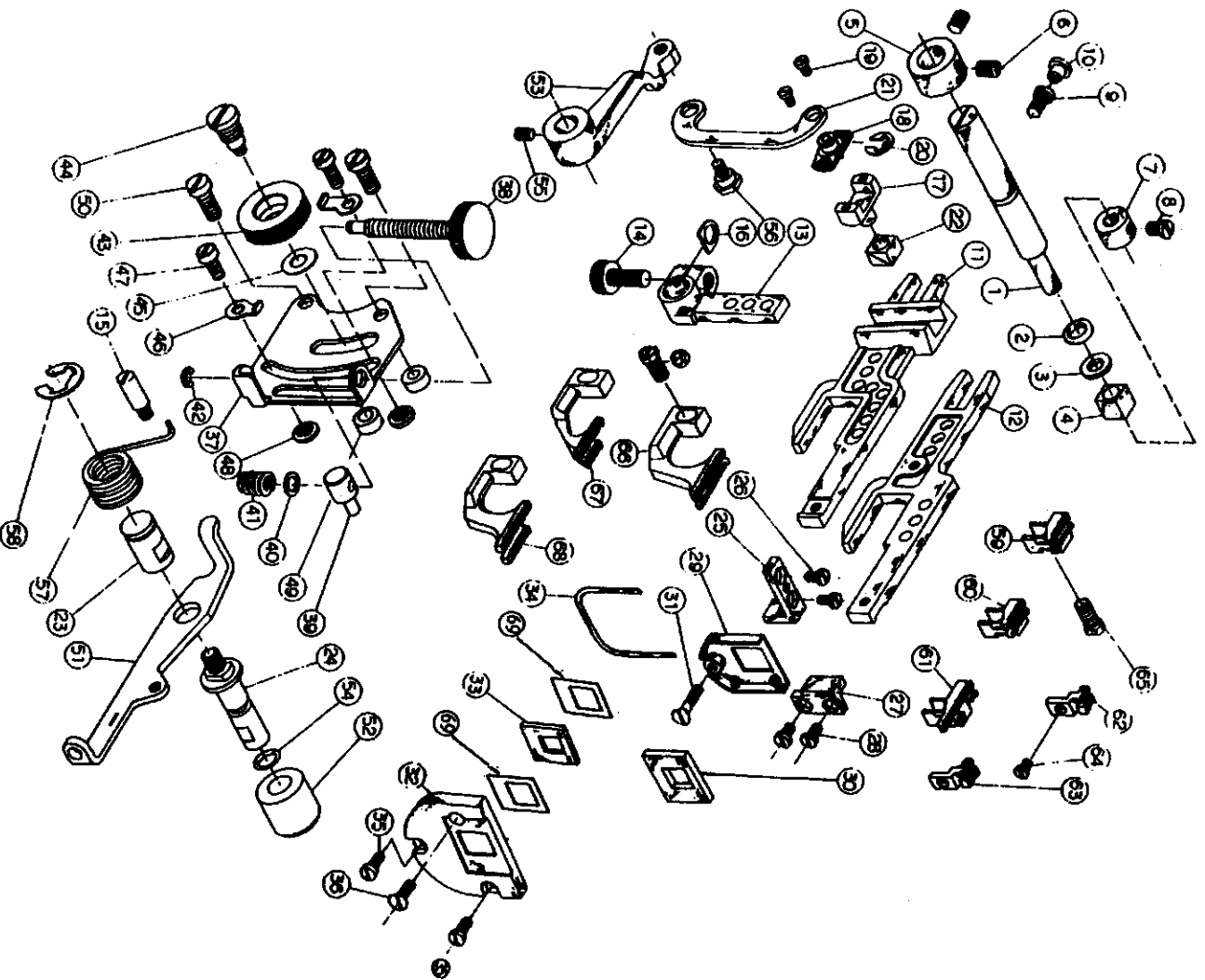

Ref.No DESCRIPTION

PARTS NO.

QUANTITY

Ref.No	DESCRIPTION	PARTS NO.	QUANTITY
1	Feed bar shaft	6030601A300	1
2	Rubber mix	CRP08	1
3	Washer	6030603B700	1
4	Slide block	6030604A400	1
5	Collar	6030605D300	1
6	Screw	SC36330500A	2
7	Collar	6030607D300	1
8	Screw	S84440708A	1
9	Screw	S84440706A	1
10	Nut	6030610A600	1
11	Main feed bar	6030612A100	1
12	Differential feed bar	6030613A100	1
13	Differential feed rocker	MM106301210A	1
14	Screw	S84440709A	1
15	Shaper Screw	6030616B700	1
16	Washer	6030617A100	1
17	Slide block	6030618A100	1
18	Slide block	S832440555A	2
19	Screw	ER05	1
20	Resainer E	6030621B700	1
21	Link	6030622A400	1
22	Slide block	6030623B300	1
23	Nut	6030625A400	1
24	Hinge Screw	6030626B300	1
25	Feed bar support	6030628B300	1
26	Screw	SC3640706D	2
27	Feed bar support	6030627B700	1
28	Screw	S83640055A	2
29	Rubber cover	6030629B700	1
30	Rubber	6030630B600	1
31	Screw	SE36401107A	1
32	Rubber case	6030632C200	1
33	Rubber	6030633B600	1
34	Rubber rim	6030634A600	1
35	Screw	SC3640080D	2
36	Screw	SE36401107A	1
37	Differential Feed Guidance	6030637B700	1
38	Adjusting screw	6030638D300	1
39	Differential feed block	6030639C300	1
40	Washer	6030640B700	1
41	Spring	6030641A800	1
42	Resainer E	ER03	1
43	Lock nut	6030643C300	1
44	Hinge screw	6030644C300	1
45	Washer	6030645B700	1
46	Washer	6030646B700	2
47	Screw	SC3640060D	2
48	Nut	6030648D300	2
49	Washer	6030649D300	2
50	Screw	SC48281208D	1
51	Rocker shaft	6030651B700	1
52	Roller	6030652A500	1
53	Differential feed rocker	6030653B200	1
54	Rubber rim	CRP05	1
55	Screw	S84028080DE	1
56	Hinge screw	SK44400691E	1
57	Spring	6030657A800	1
58	Resainer E	ER09	1
59	Differential feed dow	FD060821	1
60	Differential feed dow	FD060971	1
61	Differential feed dow	FD060828	1
62	Auxiliary feed dow	AF060871	1
63	Auxiliary feed dow	AF060874	1
64	Screw	S8132440705A	2
65	Screw	SK44400907A	1
66	Main feed dow	DF80407	1
67	Main feed dow	DF85209	1
68	Main feed dow	DF8148E	1
69	Washer	6030669	2

(7) UPPER AND LOWER LOOPER COMPONENTS

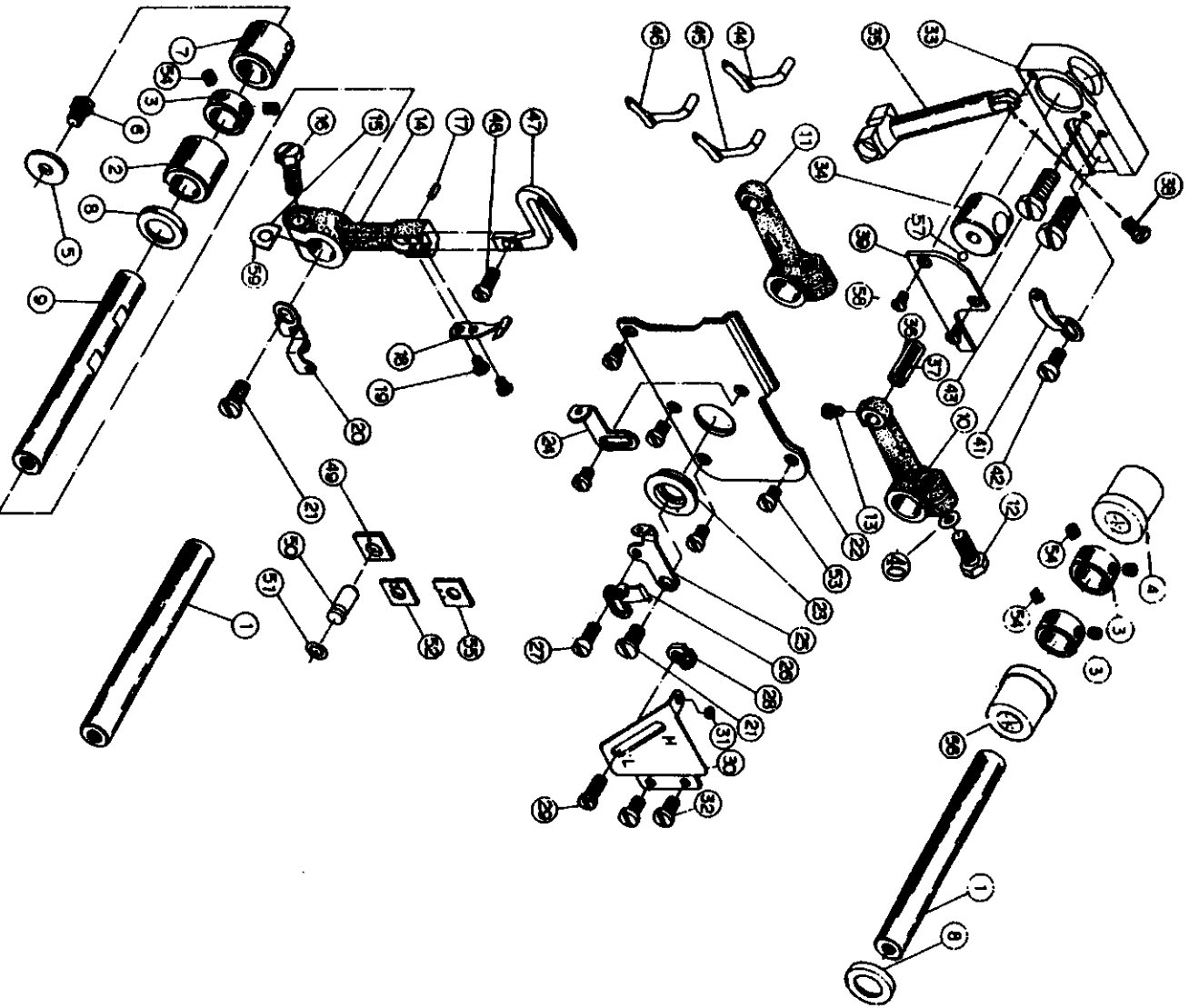

NO.	DESCRIPTION	QUANTITY
1	Upper looper shaft	1
2	Bushing	1
3	Thrust collar	1
4	Bushing	1
5	Washer	1
6	Screw	1
7	Bushing	1
8	Rubber ring	1
9	Lower looper shaft	1
10	Crank	1
11	Crank	1
12	Screw	1
13	Screw	1
14	Lower looper support arm	1
15	Washer	1
16	Screw	1
17	Spring pin	1
18	Traveling needle guide	1
19	Screw	1
20	Looper thread take-up	1
21	Screw	1
22	Oil shield plate	1
23	Oil seal	1
24	Thread guide	1
25	Looper thread take up	1
26	Thread take up	1
27	Screw	1
28	Lower looper thread guide	1
29	Screw	1
30	Looper thread take up cover	1
31	Thread guide	1
32	Screw	1
33	Guide support	1
34	Lever guide	1
35	Upper looper lever	1
36	Pin	1
37	Oil wick	1
38	Screw	1
39	Guide cover	1
40	Washer	1
41	Thread guide	1
42	Screw	1
43	Screw	1
44	Upper looper	1
45	Upper looper	1
46	Upper looper	1
47	Lower looper	1
48	Screw	1
49	Slopper	1
50	Pin	1
51	Rubber ring	1
52	Slopper	1
53	Screw	1
54	Screw	1
55	Slopper	1
56	Bushing	1
57	Oil wick cover bushing	1
58	Screw	1
59	Washer	1

1 For OV-604 - OV-614
2 For OV-604 - OV-616
3 For OV-616
4 For OV-614
5 For OV-604 - OV-616(Needle #8-#13)
6 For OV-604 - OV-616(Needle #14-#20) and OV-616(Needle #6-#8)
7 For OV-604 - OV-616(Needle #21) and OV-614(Needle #9-#16)
8 For OV-634-240

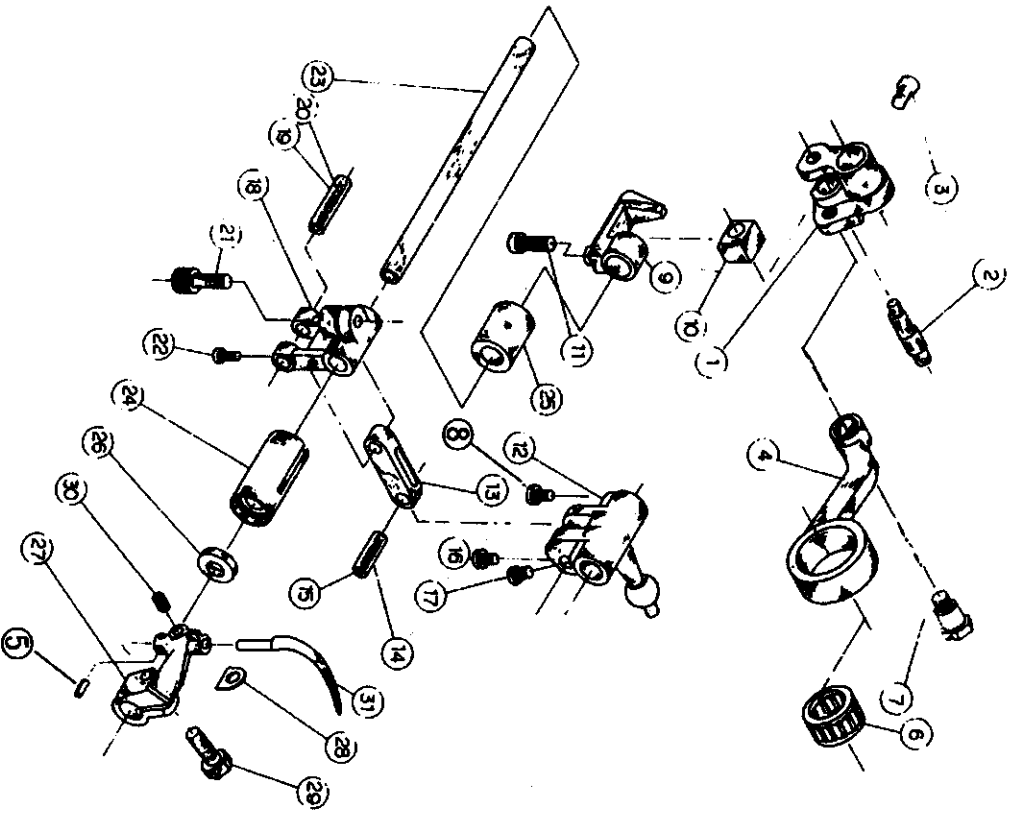

Ref.No	DESCRIPTION	PARTS NO.	QUANTITY
1	Chain looper shaft slide arm	6050801A100	1
2	Slide block pin	6050802A300	1
3	Screw	SB44400706A	1
4	Chain looper rod	6050804A100	1
5	Spring Pin	SP0208	1
6	Bearing	NB18221000	1
7	Screw	SK56321309E	1
8	Screw	SN44400706A	1
9	Bracket	6050809A100	1
10	Slide block	6050810A400	1
11	Screw	SB48321207A	1
12	Ball stud	6050812A100	1
13	Driving link	6050813A400	1
14	Pin	6050814A300	1
15	Oil wick	6707	1
16	Screw	SB36400505A	1
17	Screw	SN44400706A	1
18	Driving arm	6050818A100	1
19	Pin	6050819A300	1
20	Oil wick	6707	1
21	Screw	MM06301210A	1
22	Screw	SB36400505A	1
23	Chain looper shaft	6050823A300	1
24	Bushing	6050824G300	1
25	Bushing	6050825G300	1
26	Oil seal	6050826A600	1
27	Driving arm	6050827D100	1
28	Washer	6050828B700	1
29	Screw	SK60281007F	1
30	Screw	SN44400400E	1
31	Chain looper	CL605294	1

(9) PRESSER FOOT COMPONENTS

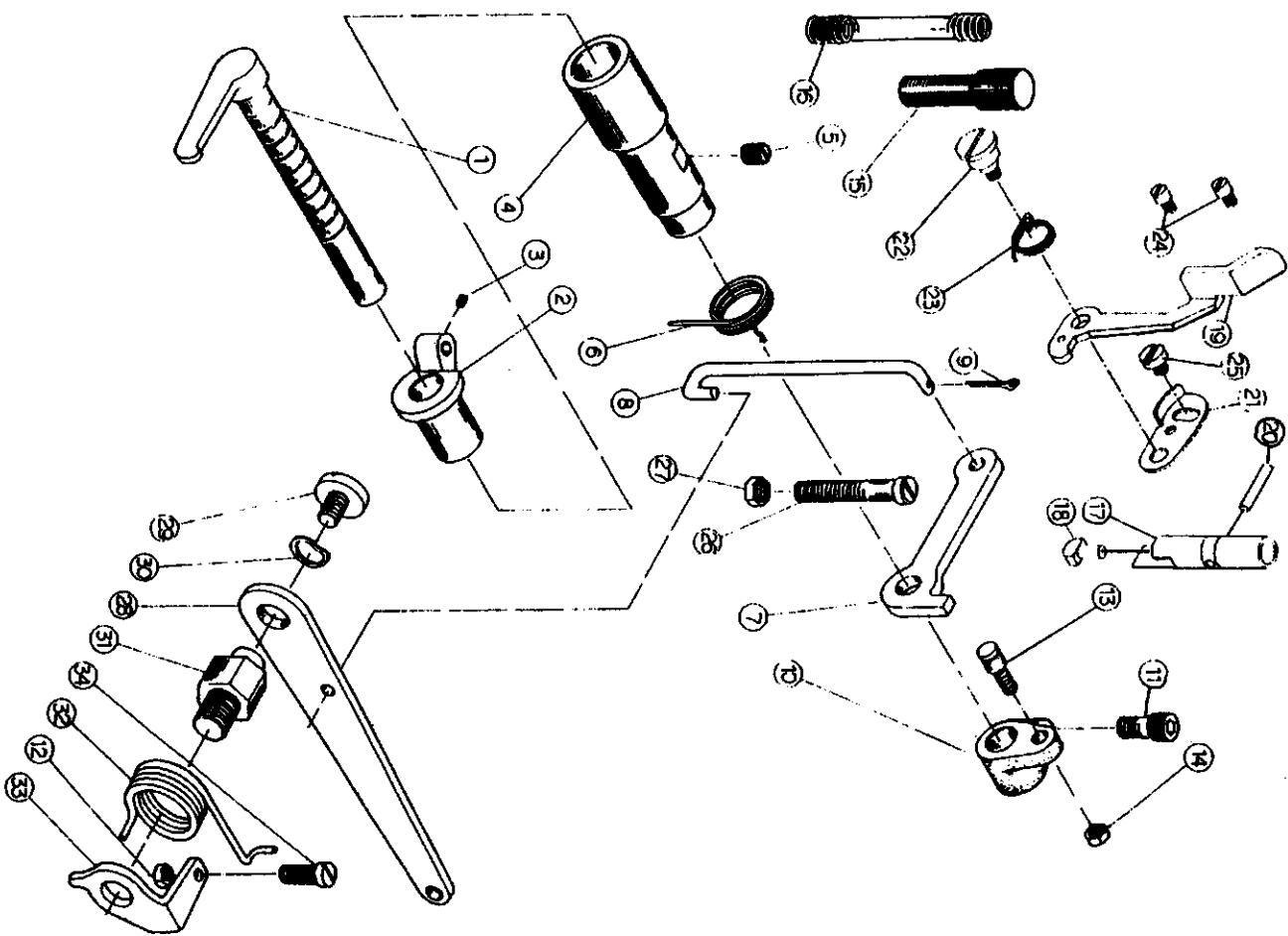

Ref.No	DESCRIPTION	PARTS NO.	QUANTITY
1	Presser foot shaft	6030901A100	1
2	Bushing	6030902 E200	1
3	Screw	MN04280400E	1
4	Bushing	6030904F300	1
5	Screw	SG60280700A	1
6	Spring	6030906A800	1
7	Lifting arm	6030907B700	1
8	Lifting hook	6030908B800	1
9	Split pin	SL0220	1
10	Presser foot Shaft Thrust arm	6030910A100	1
11	Screw	MM06301210A	1
12	Nut	SA44400307A	1
13	Screw	SB44401705I	1
14	Nut	SA44400307A	1
15	Presser Spring regulator	7030915D300	1
16	Spring	6030916A800	1
17	Presser bar	6030917A300	1
18	Plunger	6030918D600	1
19	Presser foot lifting lever	7030919B700	1
20	Spring Pin	SP0318	1
21	Base	7030921B700	1
22	Lifting lever screw	6030922D300	1
23	Spring	6030923A800	1
24	Screw	SB36400505M	2
25	Screw	SC44400508D	1
26	Screw	SK60283608G	1
27	Nut	SA60280309A	1
28	Lifting lever	6030928B700	1
29	Screw	SC64240916C	1
30	Waved washer	6030930D700	1
31	Lifting lever screw	6030931D300	1
32	Spring	6030932A800	1
33	Presser foot lifting lever stopper	6030933B700	1
34	Screw	SK44401307A	1

00 PRESSER FOOT COMPONENTS

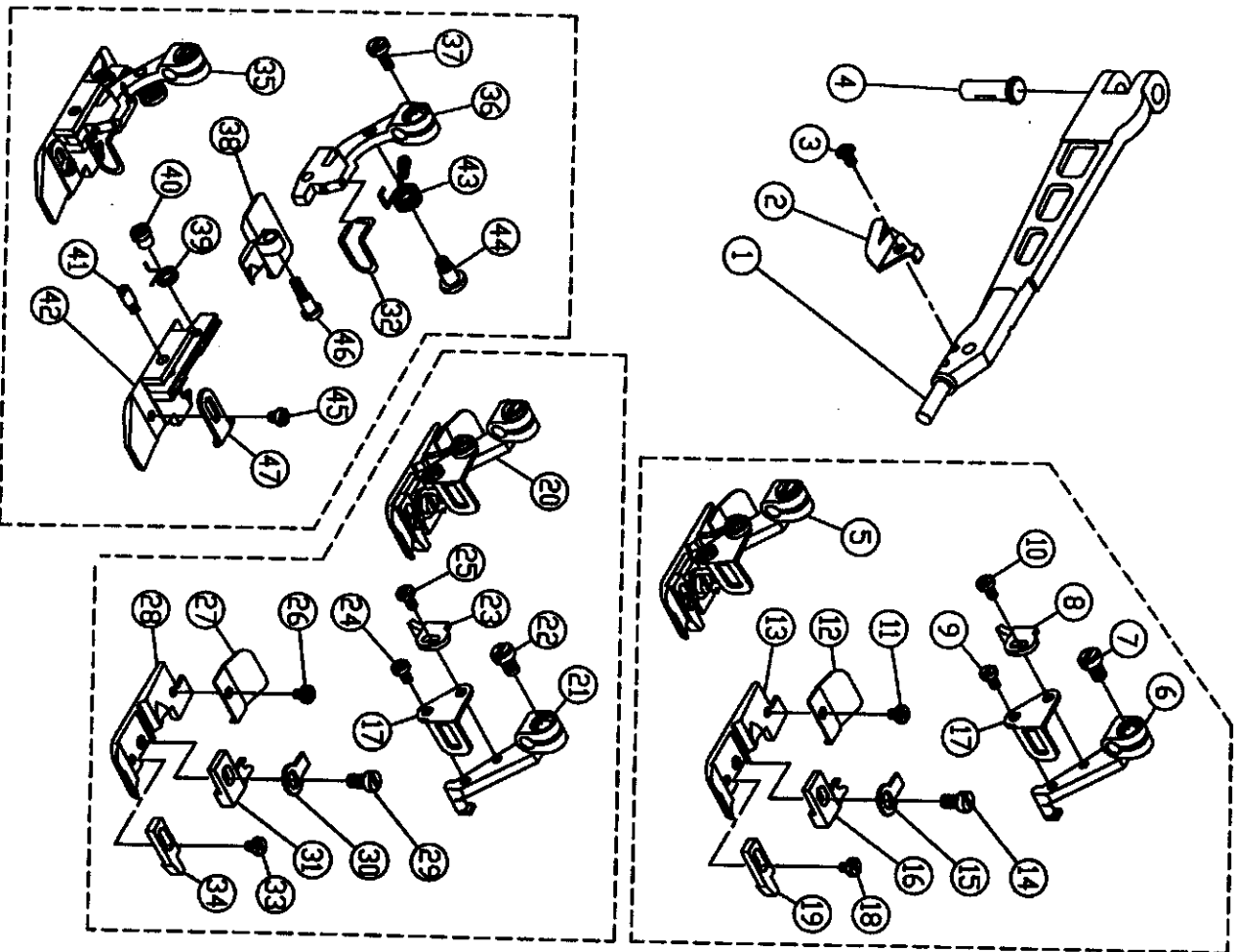

RefNo	DESCRIPTION	PARTS NO.	QUANTITY
1	Presser foot arm	7031001 E200	1
2	Thread retrimmer	6031002D700	1
3	Screw	SB24560405A	1
4	Pin	6031004A300	1
5	Presser foot asm	PF603032	1
6	Presser foot hinge	PF603032A	1
7	Screw	SB36400606A	1
8	Stopper	PF603032E	1
9	Screw	SB24560405A	1
10	Screw	SB24560405A	1
11	Screw	SB24560405A	1
12	Rear presser foot	PF603032E	1
13	Presser foot	PF603032B	1
14	Screw	SB32440505A	1
15	Spring	PF603032G	1
16	Stitch tongue	PF603032C	1
17	Collar	PF603032H	1
18	Screw	SB24560405A	1
19	Curl guard	PF603032D	1
20	Presser foot asm	PF604A32	1
21	Presser foot hinge	PF603032A	1
22	Screw	SB36400606A	1
23	Stopper	PF603032E	1
24	Washer	SB24560405A	1
25	Screw	SB24560405A	1
26	Screw	SB24560205A	1
27	Rear presser foot	PF604A32E	1
28	Presser foot	PF604A32B	1
29	Screw	SB32440505A	1
30	Spring	PF603032G	1
31	Stitch tongue	PF604A32C	1
32	Collar	PF605C32H	1
33	Screw	SB24560405A	1
34	Curl guard	PF603032D	1
35	Presser foot asm	PF605C32	1
36	Presser foot hinge	PF605A32A	1
37	Screw	SB36400606A	1
38	Rear presser foot	PF605C32C	1
39	Spring	PF605A32F	1
40	Nut	PF605A32G	1
41	Hinge pin	SB24560303C	1
42	Hinge type presser foot	PF605C32B	1
43	Spring	PF605D53E	1
44	Screw	SB32440807E	1
45	Screw	SB24560305A	1
46	Screw	SB24561105E	1
47	Auxiliary stopper	PF605A32D	1

.1 For OV-604
 .2 For OV-614
 .3 For OV-616

00 THREAD TENSION COMPONENTS

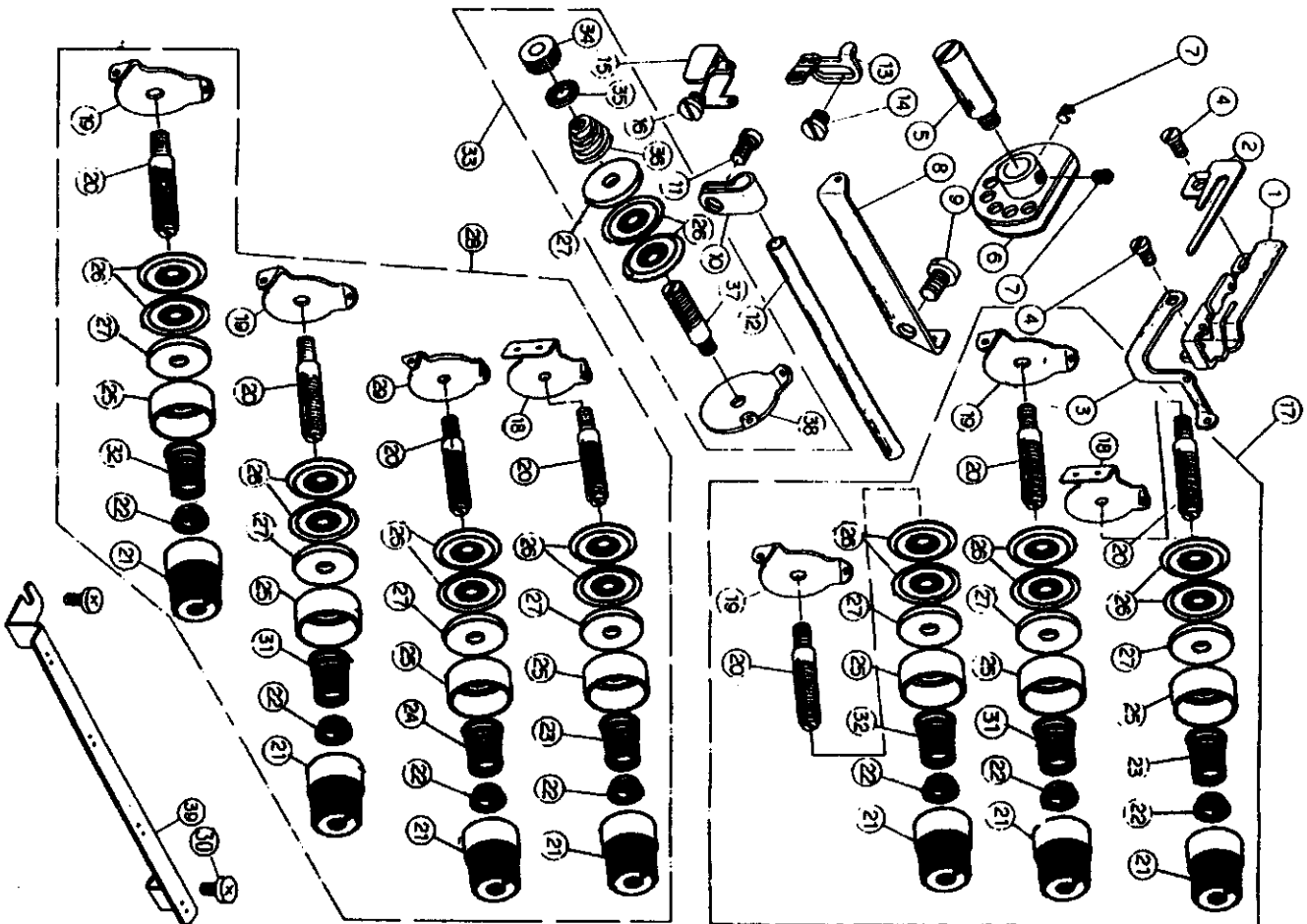

Ref.No	DESCRIPTION	PARTS NO.	QUANTITY
1	Chain looper thread guide	6051101B700	1
2	Hook	6051102B700	1
3	Chain looper thread guide	6051103B700	1
4	Screw	SC36400806D	2
5	Stud	6051105D300	1
6	Thread cam	6051106B700	1
7	Screw	6051105B700	1
8	Thread guide	SN44400400E	2
9	Screw	6051105B700	1
10	Mounting bracket	SC60281310D	1
11	Screw	6051108B700	1
12	Thread guide tube	SC44400907D	1
13	Needle thread guide	6051112D300	1
14	Screw	6031113B700	1
15	Needle thread guide	SC44400808D	1
16	Screw	6051115B700	1
17	Thread tension spring asm	SC44400808D	1
18	Thread guide	6031101A	1
19	Thread guide	R6031118B700	1
20	Stud	6031119B700	2
21	Nut	R6031120C300	4
22	Bushing	6031121D600	7
23	Spring(Red)	6031122D600	7
24	Spring(Green)	6031123A800	2
25	Spring tube	6031124A800	1
26	Tension disc	6031125D600	7
27	Felt	6031126D700	16
28	Tension controller asm	6031127L700	8
29	Thread guide	6041102A	1
30	Screw	R6041129B700	1
31	Spring(Yellow)	R6031140	1
32	Spring(Blue)	6041131A800	2
33	Tension controller asm	6051132A800	2
34	Nut	6051103A	1
35	Tension disc stopper	6051134D300	1
36	Spring	6051135B700	1
37	Stud	6051136A800	1
38	Thread guide	6051137C300	1
39	Thread guide	6051138B700	1
		R6031139	1

.1 For OV-616
 .2 For OV-604
 .3 For OV-614 - OV-616

UPPER KNIFE COMPONENTS

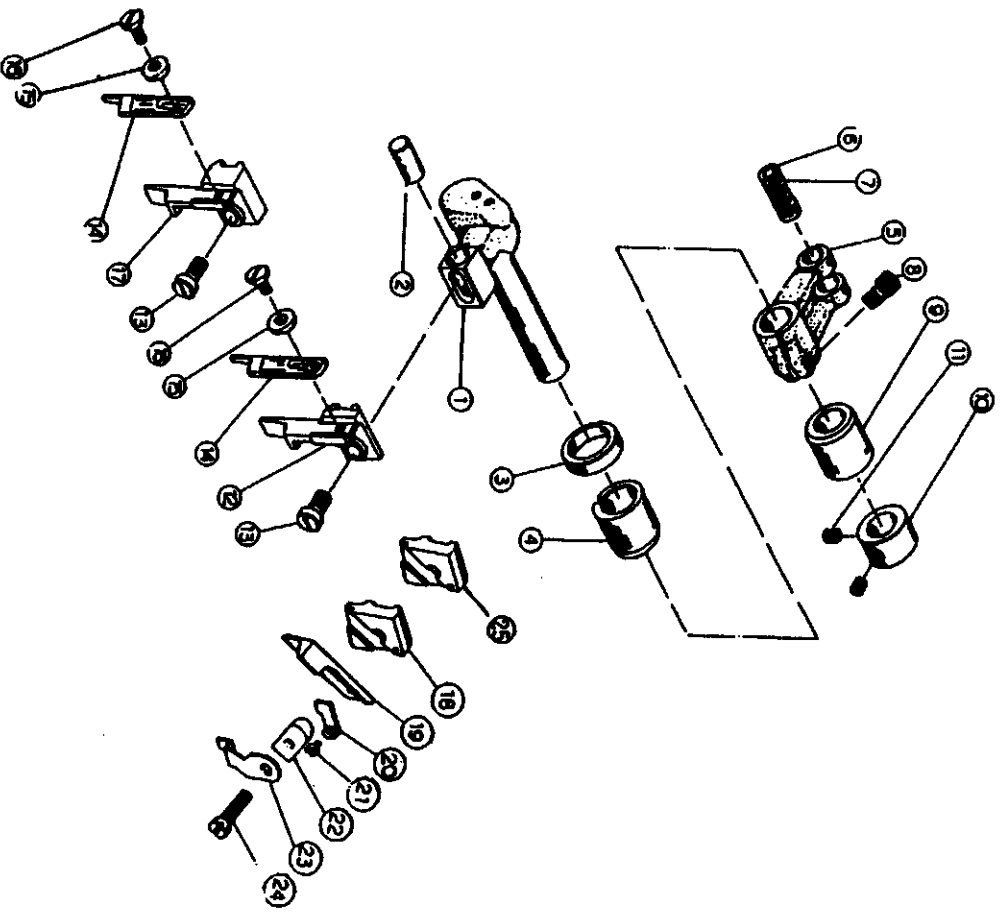

Ref.No	DESCRIPTION	PARTS NO.	QUANTITY
1	Knife driving arm	6031301A100	1
2	Pin	6031302B300	1
3	Oil seal	6031303A600	1
4	Bushing	6031304G300	1
5	Crank	6031305A100	1
6	Crank pin	6030427A300	1
7	Oil wick	6707	1
8	Screw	MM06301210A	1
9	Bushing	6031309G300	1
10	Thrust collar	6031310D300	1
11	Screw	SG56320500A	2
12	Upper knife support	6031312E200	1
13	Screw	SC44401008A	1
14	Knife	6031314D700	1
15	Washer	PW040912	1
16	Screw	SK36400707G	1
17	Upper knife support	6051317E200	1
18	Angle knife holder	6051318D100	1
19	Angle knife	6051319C500	1
20	Washer	6051320B700	1
21	Screw	SB24560304A	1
22	Presser plate	6051322A500	1
23	Angle knife cover	6051323B700	1
24	Screw	SK44402306G	1
25	Angle knife holder	6041325D100	1

.1 For OV-604, OV-614

.2 For OV-616

.3 For OV-616-555

00 NEEDLE COOLING MECHANISM

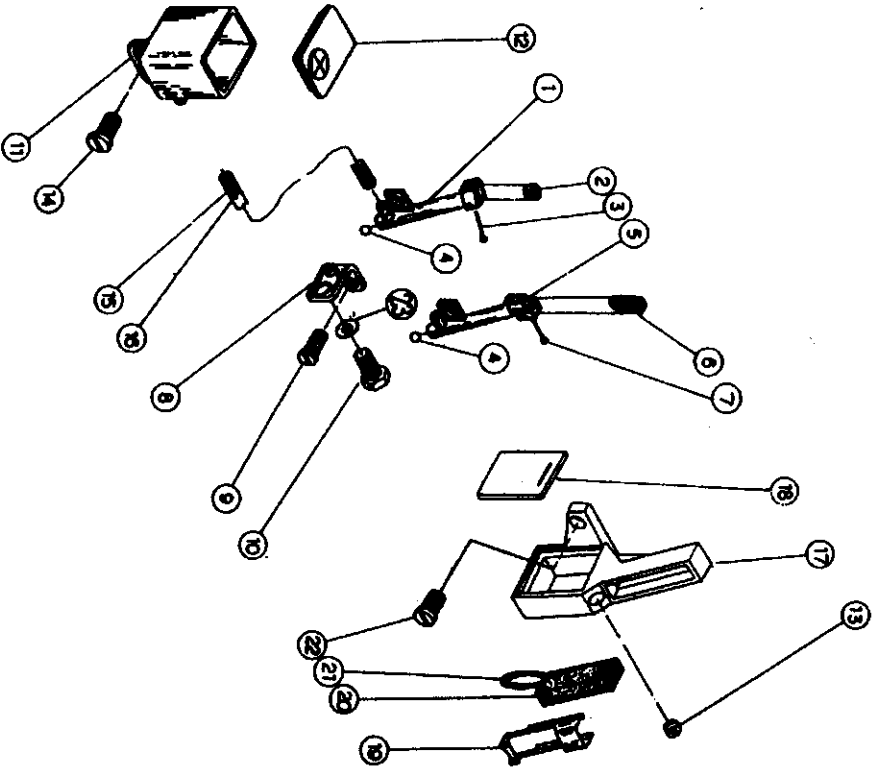

Ref.No	DESCRIPTION	PARTS NO.	QUANTITY
1	Needle cooler	6031401D200	1
.1	Felt	6031402L700	1
2	Wire	6031403D800	1
.1	Wire	6031404H300	1
3	Plug	6031404H300	1
4	Needle cooler	6051405D200	1
2	Felt	6051406D200	1
2	Felt	6051406D200	1
6	Wire	6051407D800	1
.2	Wire	6051407D800	1
7	Support	6031408B700	1
8	Support	6031408B700	1
9	Screw	SC36400707D	1
9	Screw	SC36400707D	1
10	Screw	SK44401307A	1
11	Oil tank	6031411D200	1
12	Oil tank cover	6031412A600	1
13	Plug	6031412A600	1
14	Screw	6031413A600	1
15	Oil wick	SC44401008A	1
16	Oil tube	6707	1
17	Tank	6692	1
18	Oil sign gauge	R6031417D200	1
19	Cover	6031418B600	1
20	Sponge	6031419D700	1
21	Oil wick	6031420L700	1
22	Screw	6707	1
23	Washer	SC44400808D	1
		PW051007	1
	.1 For OV-604, OV-614		
	.2 For OV-616		

19 LUBRICATION MECHANISM

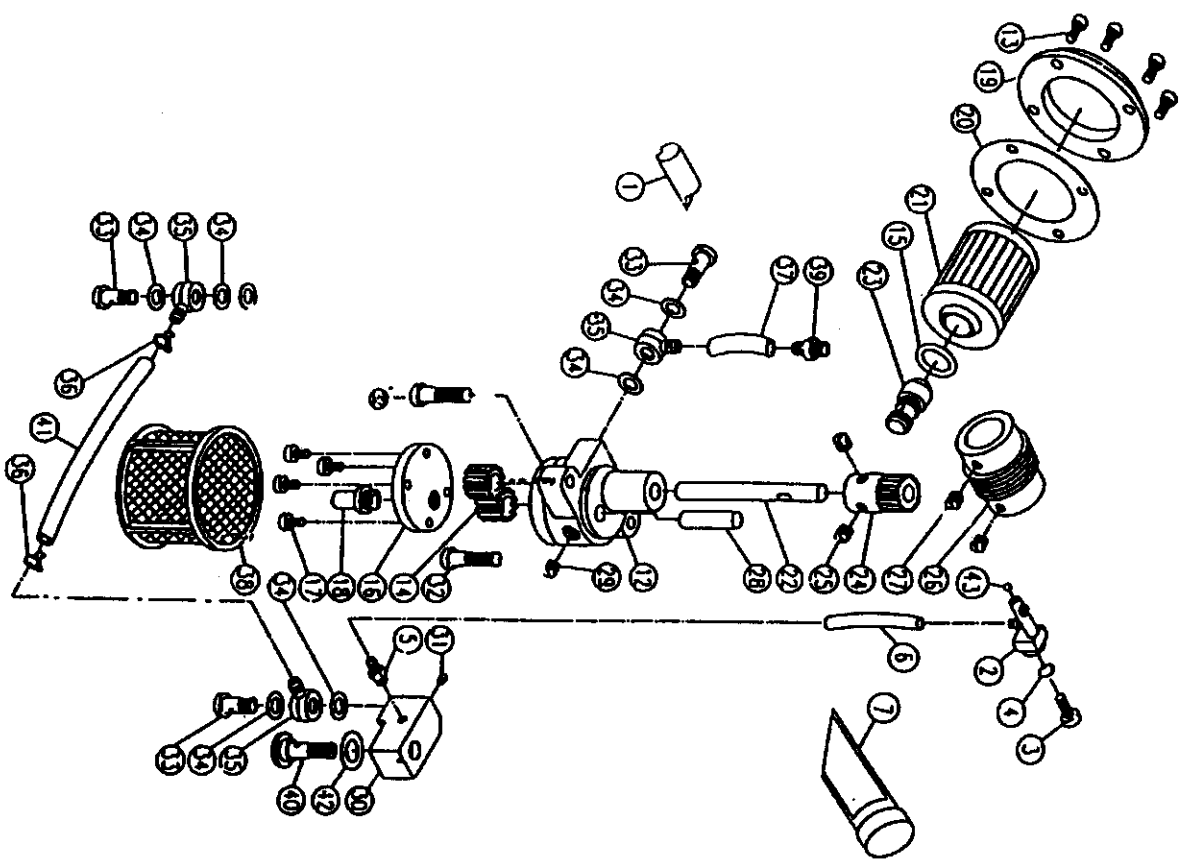

Ref.No	DESCRIPTION	PARTS NO.	QUANTITY
1	Bushing	6031501	1
2	Oil exhaust holder	6031502B700	1
3	Screw	SC44401208D	1
4	Rubber ring	ORP04	1
5	Oil tube joint	6031505G300	1
6	Oil tube	6692	1
7	Oil sign gauge	R6031507K300	1
8		-----	
9		-----	
10		-----	
11	Oil pump base	6031512A200	1
12	Screw	SC44401208D	4
13	Gear	6031514A500	2
14	Rubber ring	ORP12	4
15	Cover	6031516B700	1
16	Screw	SC36400707D	4
17	Oil tube	6031518B700	1
18	Filter cover	6031519D200	1
19	Filter seal	6031520D200	1
20	Cartridge filter	6031521G700	1
21	Shaft	6031522A300	1
22	Oil tube joint	6031523G300	1
23	Worm gear	6031524B300	1
24	Screw	SG56320500A	2
25	Worm	6031526A300	1
26	Screw	SNS6320500E	1
27	Shaft	6031528A300	2
28	Screw	SB44400807A	1
29	Distribute block	6031530D200	1
30	Plug	6031531H300	1
31	Screw	SB48282009B	1
32	Screw	6031533C300	2
33	Washer	6031534E600	3
34	Oil tube joint	6031535D600	7
35	Snap ring	6031536B800	3
36	Oil tube	6031537A600	2
37	Oil grid	6031544	1
38	Oil tube joint	6031539G300	1
39	Screw	6031540G300	1
40	Oil tube	6031541A600	1
41	Washer	6031542E600	1
42	Plug	6031543D600	1
43			1

00 THREAD STAND COMPONENTS

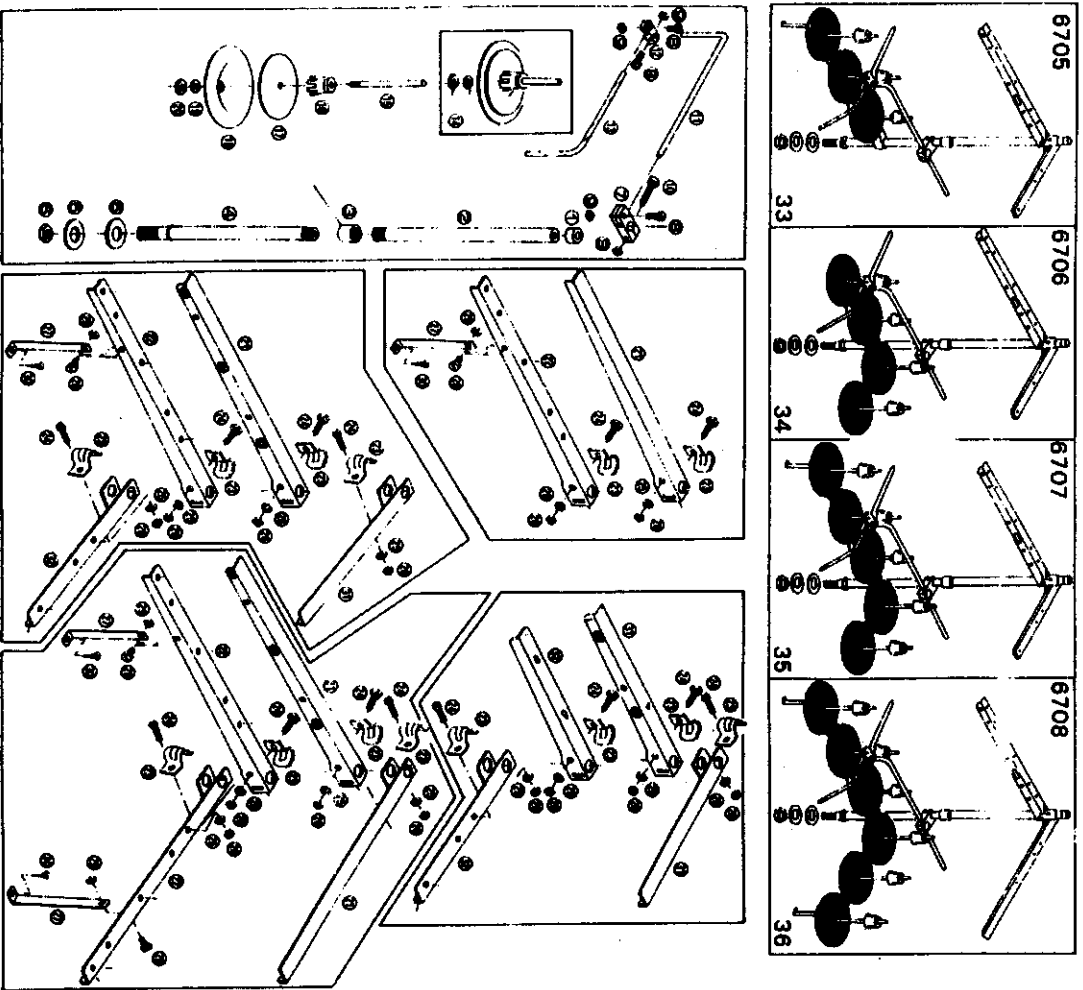

RefNo	DESCRIPTION	PARTS NO.	QUANTITY
1	Rod cup	67051	1
2	Upper Thread Stand Rod	67052	1
3	Joint	67053	1
4	Lower Thread Stand Rod	67054	1
5	Washer	67055	2
6	Nut	67056	1
7	Bracket	67057	1
8	Screw	67058	3
9	Nut	67059	4
10	Screw	670510	1
11	Arm	670511	1
12	Bracket	670512	1
13	Thread Guide	670513	1
14	Spool Set for SH7003	670514	3
	Spool Set for SH7004	670514	4
	Spool Set for SH7005	670514	5
	Spool Set for SH7006	670514	6
15	Spool Pin	670515	1
16	Spool Retaining Flg	670516	1
17	Seal	670517	1
18	Spool Tray	670518	1
19	Spring Washer	670519	1
20	Nut	670520	1
21	Thread Guide for SH7003 - SH7005	670521	1
22	Thread Guide for SH7006	670521	2
	Spool Set Bracket for SH7003 - SH7005	670522	1
	Spool Set Bracket for SH7006	670522	2
23	Clamp	670523	2
24	Screw	670524	1
25	Spring Washer	670525	1
26	Nut	670526	1
27	Support Rod for SH7003 - SH7005	670527	1
	Support Rod for SH7006	670527	2
28	Screw for SH7003 - SH7005	670528	1
	Screw for SH7006	670528	2
29	Nut for SH7003 - SH7005	670529	1
	Nut for SH7006	670529	2
30	Wood Screw for SH7003 - SH7005	670530	1
	Wood Screw for SH7006	670530	2
31	Thread Guide for SH7004	670531	2
32	Thread Guide for SH7005	670531	1
	Spool Set Bracket for SH7004	67061	1
	Spool Set Bracket for SH7005	67052	2
33	Thread Stand Asm. For SH7003	6705	1
34	Thread Stand Asm. For SH7004	6706	1
35	Thread Stand Asm. For SH7005	6707	1
36	Thread Stand Asm. For SH7006	6708	1

33 For OV-604

34 For OV-614

35 For OV-616

36 For OV-643

00 SEMI-SUNKEN TYPE TABLE COMPONENTS

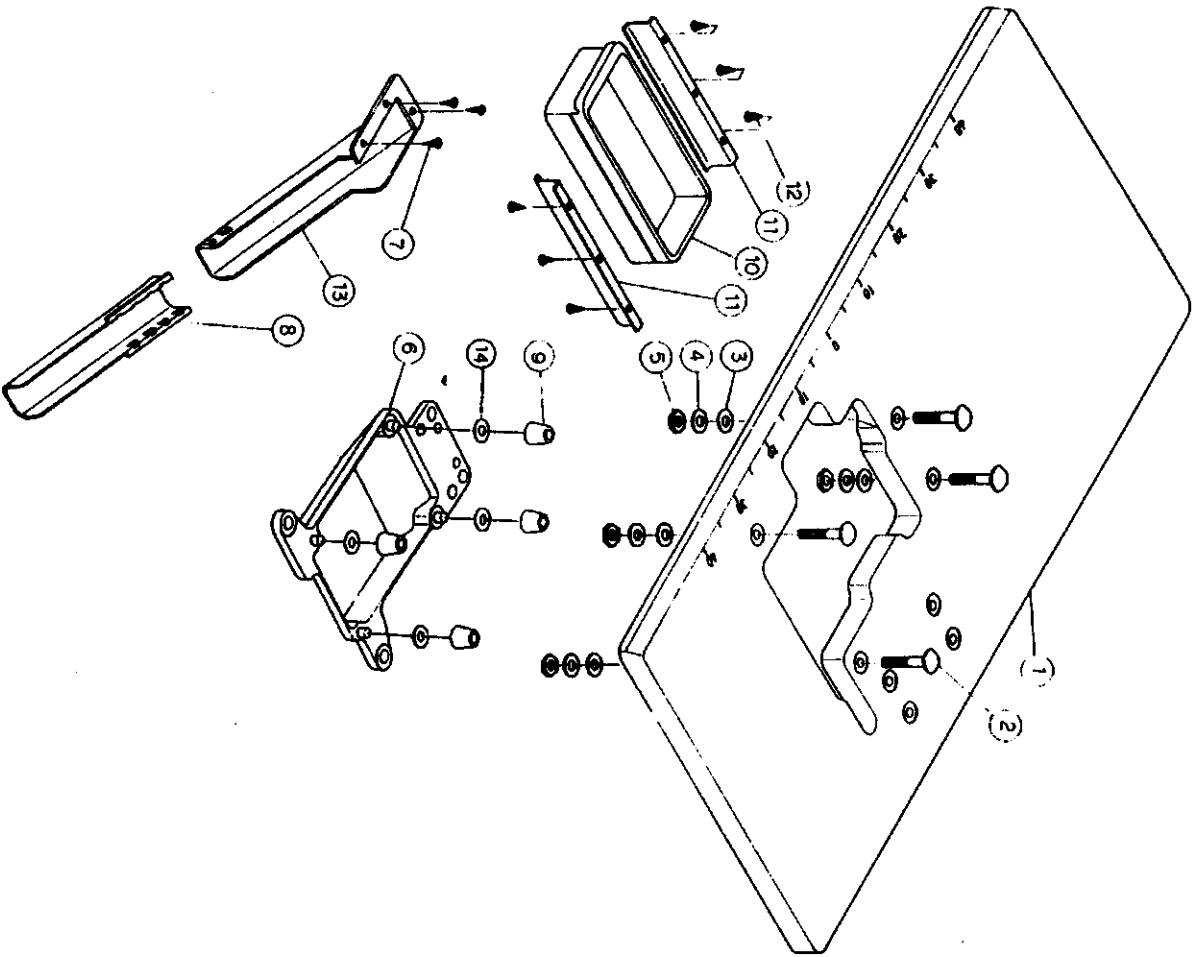

Ref.No	DESCRIPTION	PARTS NO.	QUANTITY
1	Table	6813-1	1
2	Screw	6031702D200	4
3	Washer	6031703B700	4
4	Washer	6031704B700	4
5	Nut	SA10160714A	4
6	Frame support plate	6031706C200	1
7	Screw	WR03131706A	3
8	Waste chute , lower	6742	1
9	Rubber	6031709A600	4
10	Drawer	6751	1
11	Drawer support	6752	2
12	Screw	WR05142207A	6
13	Waste chute , upper	6741	1
14	Washer	6031714B700	4

(18) FULLY SUNKEN TYPE TABLE COMPONENTS

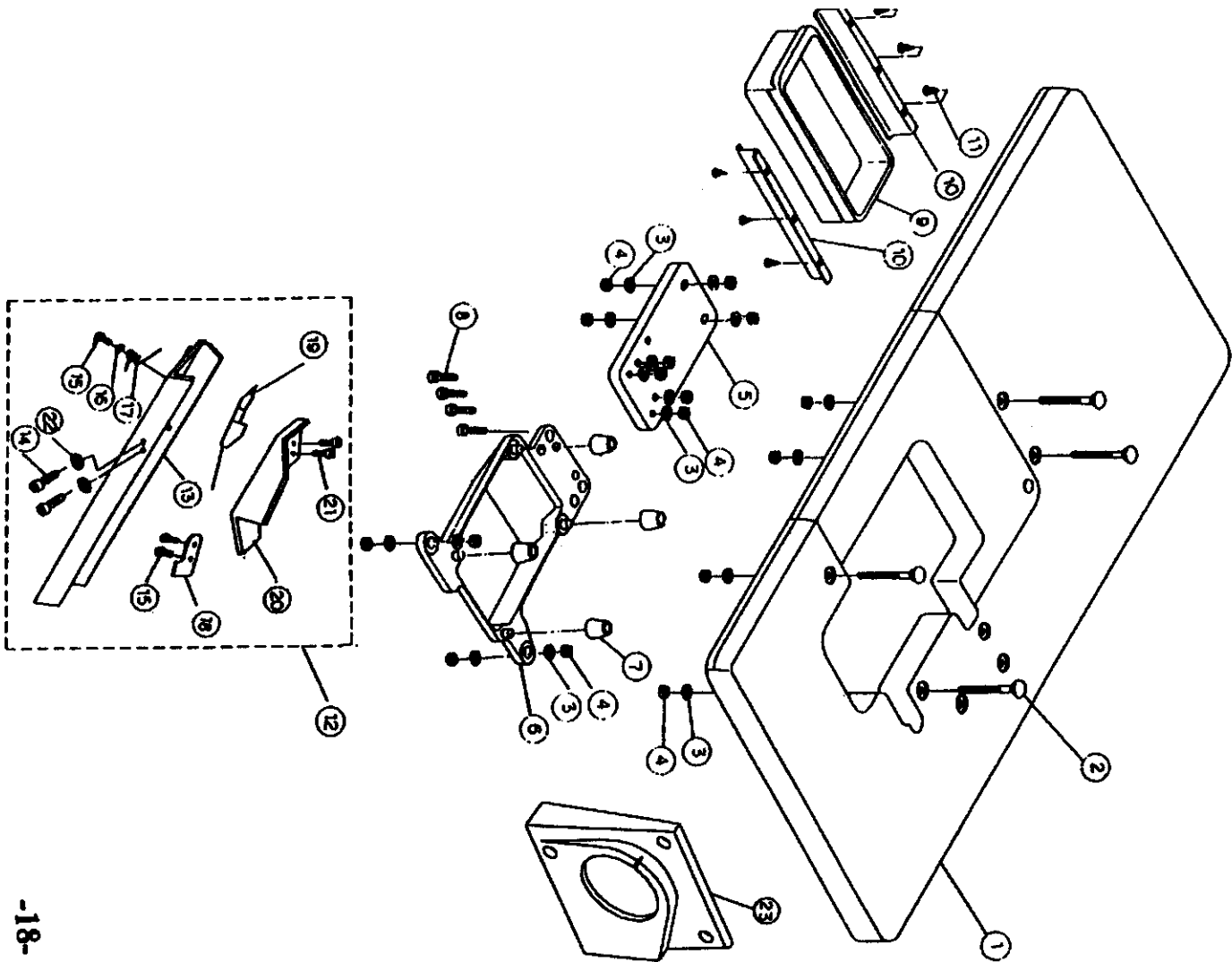

Ref.No	DESCRIPTION	PARTS NO.	QUANTITY
1	Table	68 13-2	1
2	Screw	7031802	4
3	Washer	6031704B700	16
4	Nut	SA10160714A	16
5	Frame support auxiliary plate	7031805	1
6	Frame support plate	7031806	1
7	Rubber	6031709A600	4
8	Screw	SB95283214A	4
9	Drawer	6751	1
10	Drawer support	6752	2
11	Screw	W/R05142207A	1
12	Waste chute asm.	7031812	6
13	Waste chute	7031813	1
14	Screw	SB44401407A	1
15	Screw	SB32440705A	2
16	Washer	C0000232PW	3
17	Spring	7031817	1
18	Cloth waste chute inlet lever	7031818	1
19	Rubber	7031819	1
20	Cloth waste chute inlet	7031820	1
21	Screw	SB36400406A	1
22	Washer	PW051007	2
23	Belt cover	7031823	2

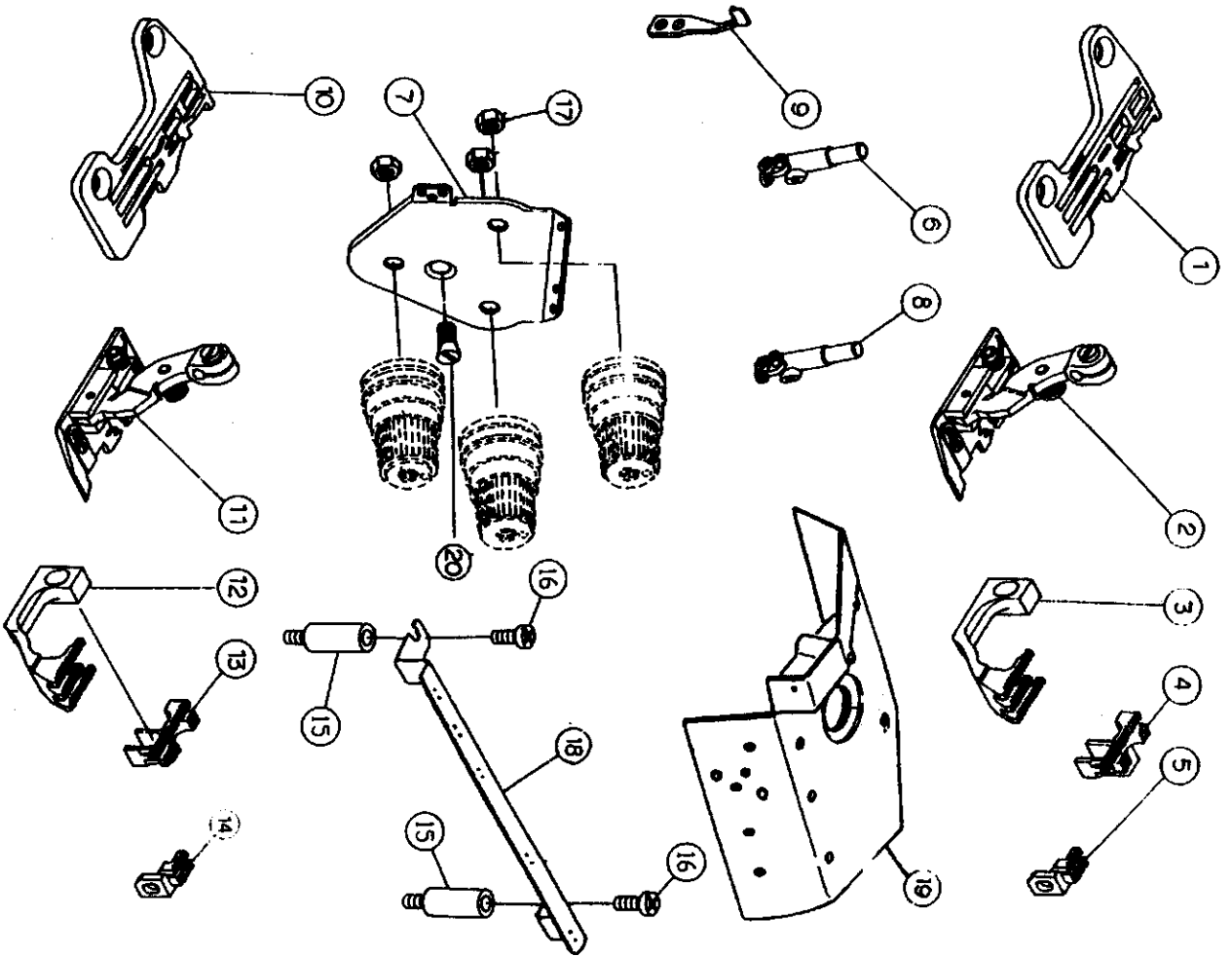

Ref.No	DESCRIPTION	PARTS NO.	QUANTITY
1	Throat plate	TP606CA3	1
1	Presser foot, complete set	PF606CA3	1
2	Differential feed dog	DF86009	1
3	Main feed dog	FD60840	1
4	Aux feed dog	AF60874	1
5	Needle clamp	NC606A33	1
6	Needle thread guide eyelet	6061907B700	1
7	Needle clamp	NC606048	1
8	Needle guide	6061909E200	1
9	Throat plate	TP606CA3	1
10	Presser foot, complete set	PF606DA3	1
11	Differential feed dog	DF86009	1
12	Main feed dog	FD60840	1
13	Aux feed dog	AF60874	1
14	Spacer	70619151	2
15	Screw	SC444400808D	2
16	Nut	SA44400307A	3
17	Thread guide	7061918	1
18	Upper cover	70619191	1
19	Screw	SF44400607C	1
20			

1 For OV-616-633
 2 For OV-616-635

<NG606908>

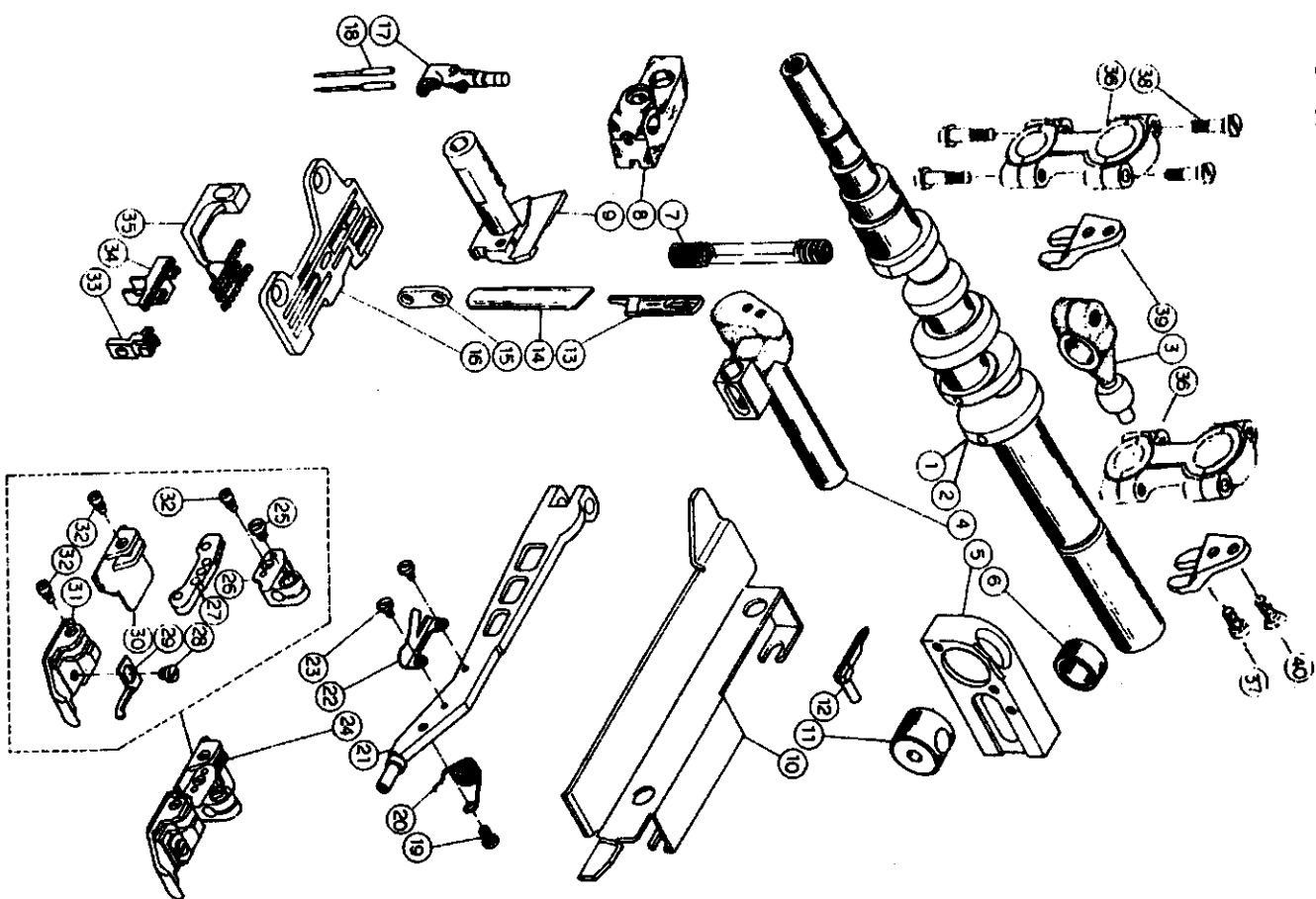

RefNo	DESCRIPTION	PARTS NO.	QUANTITY
1	Crankshaft	G6040101A300	1
2	Crankshaft	G6050102A300	1
3	Crank	G6050103A100	1
4	Knife driving	G6050104A100	1
5	Guide Support	G6050105E200	1
6	Thrust collar	G6050106D300	1
7	Spring	G6050107A800	1
8	Needle Bar Base	G6050108B200	1
9	Lower knife holder	G6050109E200	1
10	Cloth plate side cover	G6030118B700	1
11	Lever guide	G6050111H300	1
12	Upper looper	GUL605150	1
13	Knife	G6050113C500	1
14	Lower knife	G6050114P700	1
15	Washer	G6050115B700	1
16	Throat plate	GTP605D63	1
17	Needle clame	GNC605048	1
18	Needle	TV64 (B-64)	2
19	Screw	SC32440406A	1
20	Spring	G6050120A800	1
21	Presser foot arm	G7052021	1
22	Thread trimmer	G6050122D700	1
23	Screw	SB24560405A	2
24	Presser foot arm	GPF605D63	1
25	Screw	SC36400706D	1
26	Presser foot hinge	GPF605D63A	1
27	Hinged Presser foot hing	GPF605D63D	1
28	Screw	SC32440406A	1
29	Auxiliary stopper	GPF605D53E	1
30	Rear Presser foot	GPF605D63C	1
31	Hinged type presser foot	GPF605D63B	1
32	Screw	PRG605D53H16	3
33	Differential feed dog	AF60876	1
34	Differential feed dog	FD60283	1
35	Main feed dog	DF28403	1
36	Looper driving rod	G6050136C100	2
37	Screw	MB03050505A	2
38	Guide	SC44401207C	8
39	Screw	G6050140A100	2
40	Chip guard Cover	MFR3050606A	2
41	Chip guard Cover	G6050143B700	1

• For OV-616-555

(21) ACCESSORIES

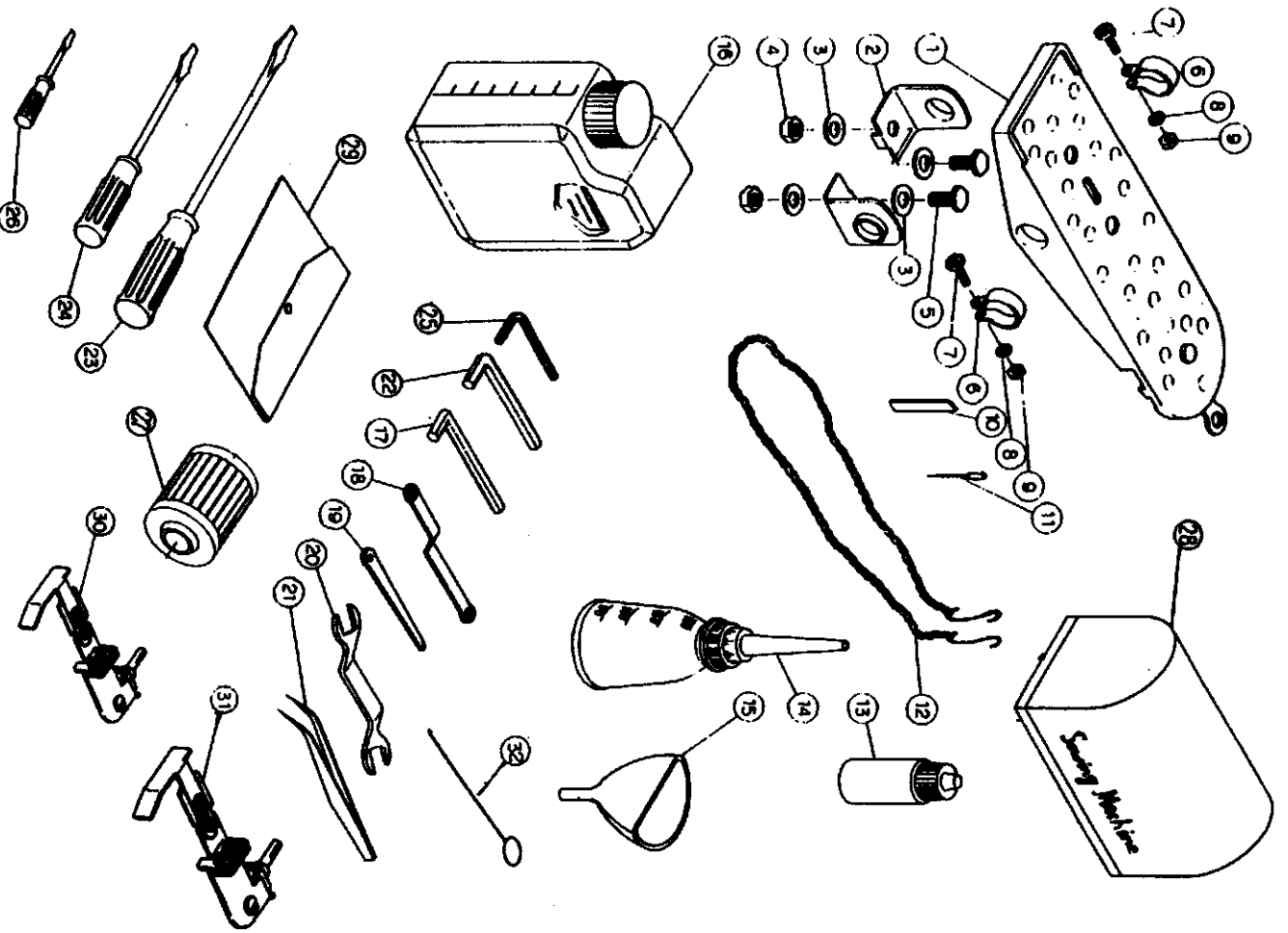

Ref.No	DESCRIPTION	PARTS NO.	QUANTITY
1	Pedal	67001	1
2	Bearing	67002	2
3	Washer	67003	4
4	Nut	67004	2
5	Screw	67005	2
6	Snap ring	67006	2
7	Screw	67007	2
8	Washer	67008	2
9	Nut	67009	2
10	Lower Knife	6031218P700	1
11	Needle	6732	10
12	Chain	6695	1
13	Oiler	6720	1
14	Container	6721	1
15	Oil Funnel	6722	1
16	Oil Container	6715	1
17	Allen Key	6635	1
18	Wrench	6655	1
19	Wrench	6656	1
20	Wrench	6625	1
21	Tweezers	6690	1
22	Allen Key	6636	1
23	Screw driver	6665	1
24	Screw driver	6666	1
25	Allen Key Driver	6639	1
26	Screw driver	6667	1
27	Cartridge Filter	6031521G700	1
28	Machine cover	6845	1
29	Accessories bag	Am-6751	1
30	Edge guide asm	EG001	1
31	Edge guide asm	REG001	1
32	Threading Bar	6840	1





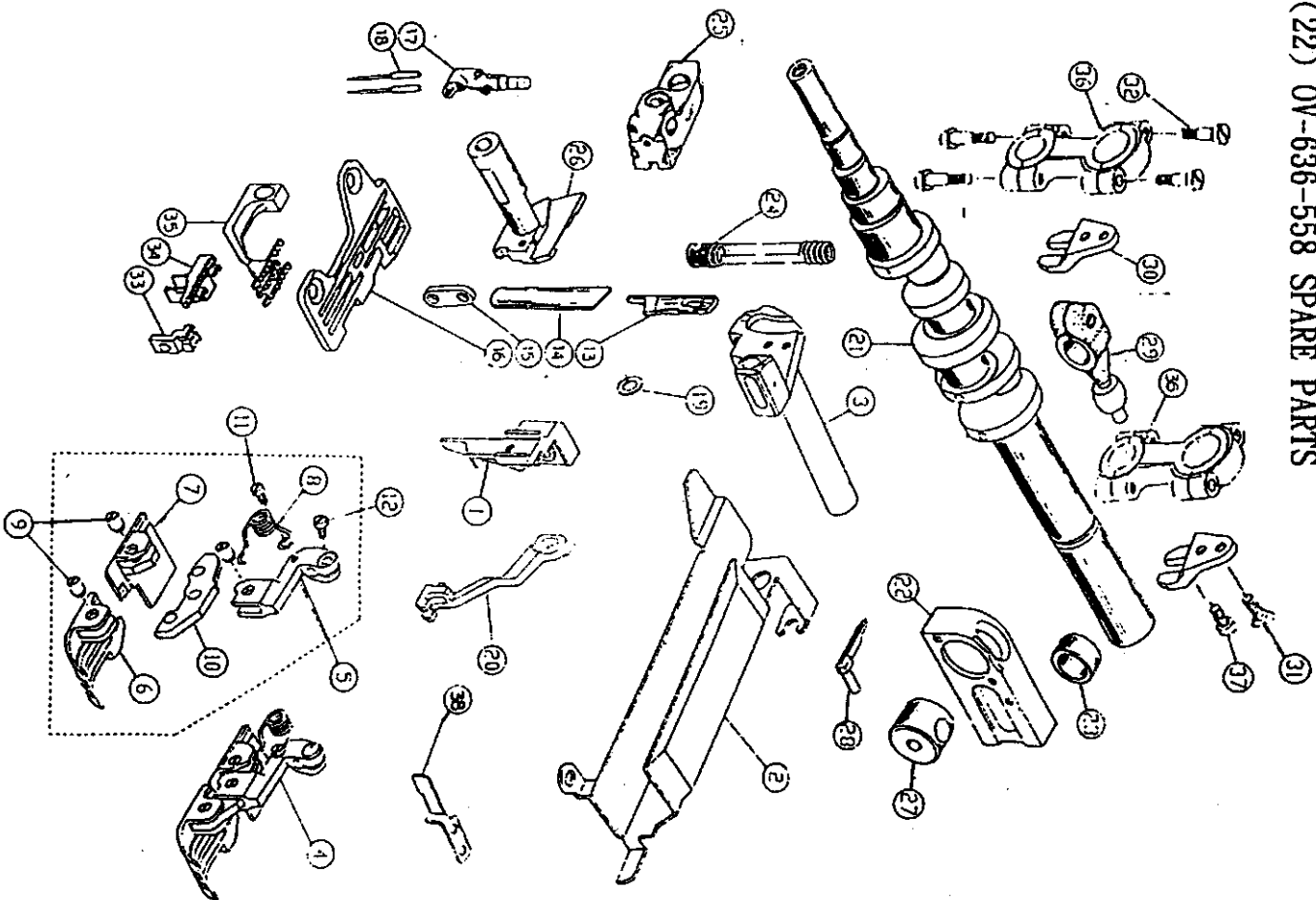





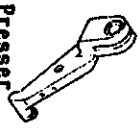

1 For OV-604 - OV-614
 2 For OV-616

(22) 0V-636-558 SPARE PARTS















Ref.No	DESCRIPTION	PARTS NO.	QUANTITY
1	Upper knife support	J6052101E200	1
2	Cloth plate side cover	J6052102	1
3	Knife driving	J6052103A100	1
4	Presser foot arm	JPF605D53	1
5	Presser foot hinge	JPF605D53A	1
6	Hinged type presser foot	JPF605D53B	1
7	Rear presser foot	JPF605D53C	1
8	Spring	J6052108	1
9	Screw	J6052109	3
10	Hinged presser foot hing	JPF605D53D	1
11	Screw	SB36400505A	1
12	Screw	SB36400606A	1
13	Knife	G6050113C300	1
14	Lower knife	G6050114P700	1
15	Washer	G6050115B700	1
16	Throat plate	GTR605D63	1
17	Needle clamp	GNC605048	1
18	Needle	TV64 (B-64)	2
19	Washer	J6052119B700	1
20	Top feed dog	JFD605D53	1
21	Crankshaft	G6050102A300	1
22	Guide Support	G6050105E200	1
23	Thrust collar	G6050106D300	1
24	Spring	G6050107A800	1
25	Needle Bar Base	G6050108B200	1
26	Lower knife holder	G6050109E200	1
27	Lever guide	G6050111H300	1
28	Upper looper	GUL605150	1
29	Crank	G6050103A100	1
30	Guide	G6050140A100	2
31	Screw	MP03050606A	2
32	Screw	SC44401207C	8
33	Differential feed dog	AF60876	1
34	Differential feed dog	FD60283	1
35	Main feed dog	DF28403	1
36	Looper driving rod	G6050136C100	2
37	Screw	MB03050505A	2
38	Chip guard Cover	G6050143B700	1



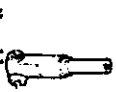



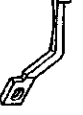







List of Main Spare Parts

Main Parts	Models	Throat Plate	Presser foot asm	Presser foot hinge	Presser foot	Stitch tongue	Main feed dog	Differential feed dog	Auxiliary feed dog	Upper looper	Lower looper	Chip guard cover	Needle clamp
OV-603-000	TP603032												
OV-604-000	TP603032	PF613032	PF603032A	PF613032B	PF613032C	FD60821	DF8040T	AF60871	UL603880	LL603884	7030131 B700	NC603033	
OV-604-010	TP6B3022	PF6B3022	PF603032A	PF603032B	PF6B3022C	FD60821	DF8040T	AF60870	UL603880	LL603884	7030131 B700	NC603033	
OV-604-050	TP603053	PF603052	PF603032A	PF603052B	PF603052C	FD60822	DF85100	AF60871	UL603880	LL603884	7040132 B700	NC603033	
OV-604-050BL	TP623032	PF603032	PF603032A	PF603032B	PF603032C	FD60821	DF8040T	AF60871	UL603880	LL603884	7040132 B700	NC603033	
OV-604-057	TP603053	PF6B3053	PF603032A	PF6B3053B	PF603052C	FD60822	DF85100	AF60871	UL603880	LL603884	7040132 B700	NC603033	
OV-604-059	TP643033	PF643033	PF603032A	PF603052B	PF603032C	FD60834	DF814BL	AF60871	UL603880	LL603884	7040131 B700	NC603033	
OV-604-055	TP603063	PF603062	PF603032A	PF604B33B	PF603052C	FD60822	DF85100	AF60871	UL603880	LL603884	7040132 B700	NC603033	

List of Main Spare Parts

Main Parts Models	Throat Plate 	Presser foot asm 	Presser foot hinge 	Presser foot 	Stitch tongue 	Main feed dog 	Differential feeddog 	Auxiliary feeddog 	Needle clamp 	Upper looper 	Lower looper 	Chip guard cover 	Needle guide 
OV-614-240	TP604A43	PF604A32	PF603032A	PF604A32B	PF604A32C	FD60824	DF86504	AF60871	NC604022	UL604883	LL603884	7040132 B700	NC604903
OV-614-245	TP694A43	PF694A43	PF603032A	PF604A43B	PF604A32C	FD60824A	DF86504A	AF60871	NC604022	GUL604152	LL604885	7040132 B700	NC604903
OV-614-247	TP604A43	PF684A43	PF683053A	PF683053B	PF604A32C	FD60824	DF86504	AF60871	NC604022	UL604883	LL603884	7040132 B700	NC604903
OV-614-249	TP644A33	PF644A33	PF603032A	PF643033B	PF604A32C	FD60834	DF814BL	AF60871	NC604022	UL604883	LL603884	7040132 B700	NC604903
OV-614-240BL	TP624A43	PF604A32	PF603032A	PF604A32B	PF604A32C	FD60824	DF86504	AF60871	NC604022	UL604883	LL603884	7040132 B700	NC604903
OV-614-240 P. D. 04	TP604A32	PF664A32	PF664A32A	PF664A32B		FD60971	DF814BE	AF60871	NC604022	UL604883	LL603884	7040132 B700	NC604903
OV-614-249 P. D. 04	TP644A33	PF674A43	PF664A32A	PF664A32B		FD60834	DF814BL	AF60871	NC604022	UL604883	LL603884	7040132 B700	NC604903
OV-614-350	TP604B53	PF604B33	PF603032A	PF604B33B	PF604B33C	FD60825	DF90706	AF60872	NC604026	UL604880	LL603884	7040132 B700	NC604904

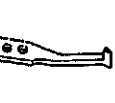
List of Main Spare Parts

Main Parts	Models															
0Y-614-400	TP634D03	PF634D03	PF634D03A	PF634D03B			FD60842	DF96108	AF60875	NC605048			BD0133 B700	NC605905	NC605910	NC816FC
0Y-614-408	TP634D03	PF634D03	PF634D03A	PF634D03B			FD60842	DF96108	AF60875	NC605048			BD0133 B700	NC605905	NC605910	NC816FC
0Y-616-330	TP605C32	PF605C32	PF605A32A	PF605C32B	PF605C32C	PF605C32C	FD60828	DF85209	AF60874	NC605032	UL603880	LL603884	7050133 B700	NC605905	NC605906	NC605907
0Y-616-550	TP605D53	PF605D53	PF605D53A	PF605D53B	PF605D53C	PF605D53C	FD60840	DF86009	AF60874	NC605048	UL603880	LL603884	7050134 B700	NC605905	NC605906	NC605907
0Y-616-350	TP605C53	PF605C32	PF605A32A	PF605C32B	PF605C32C	PF605C32C	FD60840	DF86009	AF60874	NC605032	UL603880	LL603884	7050134 B700	NC605905	NC605906	NC605907
0Y-616-339	TP605C33	PF645C53	PF605A32A	PF645C53B	PF605C32C	PF605C32C	FD60841	DF85902	AF60874	NC605032	UL603880	LL603884	7050134 B700	NC605905	NC605906	NC605907
0Y-616-359	TP605C53	PF645C53	PF605A32A	PF645C53B	PF605C32C	PF605C32C	FD60841	DF85902	AF60874	NC605032	UL603880	LL603884	7050134 B700	NC605905	NC605906	NC605907
0Y-616-559	TP645D53	PF645D53	PF605D53A	PF645D53B	PF605D53C	PF605D53C	FD60841	DF85902	AF60874	NC605048	UL603880	LL603884	7050134 B700	NC605905	NC605906	NC816FC
0Y-616-555	GTP605D63	GPF605D63	GPF605D63A	GPF605D63B	GPF605D63C	GPF605D63C	FD60283	DF28403	AF60876	NC605048	GUL605150	LL603884	7050134 B700	NC605905	NC605906	NC605907
0Y-616-330 B.D.05	TP655C32	PF655C32	PF605A32A	PF655C32B	PF605C32C	PF605C32C	FD60828	DF85209A	AF60874	NC605032	UL603880	LL603884	7050133 B700	NC605905	NC605906	NC605907
0Y-616-359 P.D.05	TP605C53	PF675C53	PF665C32A	PF665C32B			FD60841	DF85902	AF60874	NC605032	UL603880	LL603884	7050134 B700	NC605905	NC605906	NC605907

List of Main Spare Parts

Models	Main Parts	Throat Plate	Presser foot asm	Presser foot hinge	Presser foot	TOP feed dog	Main feed dog	Differ-ential feeddog	Differ-ential feeddog	Auxilli-ary feeddog	Needle clamp	Upper looper	Lower looper	Chip guard cover	Needle guide	Needle guide	Chip guard cover	Needle guide
0V-634-240		TP604A53	FPF604A32B	PPF603032A	PPF604A32B	FTD604A33	FD60824	DF8504	DF8504	AF60871	NC604022	UL604883	LL603884	LL603884	6040132	B700	B700	NC604903

Models	Main Parts	Throat Plate	Presser foot asm	Presser foot hinge	Presser foot	Top feed dog	Main feed dog	Differ-ential feeddog	Auxilli-ary feeddog	Needle clamp	Upper looper	Lower looper	Chip guard cover	Needle guide	Needle guide	Needle guide	Chip guard cover	Needle guide
0V-636-550		TP605D53	FPF605D53	PPF605D53A	PPF605D53B	FTD605D53	FD60840	DF86009	AF60874	NC605048	UL603880	LL603884	LL603884	6050134	NC605905	NC605906	NC605907	NC605907
0V-636-555		TP605D53	FPF605D53	PPF605D53A	PPF605D53B	FTD605D53	FD60830	DF85407	AF60873	NC605048	UL603880	LL603884	LL603884	6050134	NC605905	NC605906	NC605907	NC605907
0V-616-633		TP606CA3	PF606CA3	PF605A32A	PF606CA3B	PF605D53C	FD60840	DF66009	AF60874	NC606032	UL604883	LL603884	LL603884	7050134	NC605905	NC605908	NC605907	NC605907
0V-616-635		TP606DA3	PF606DA3	PF605D53A	PF606CA3B	PF605D53C	FD60840	DF66009	AF60874	NC606048	UL604883	LL603884	LL603884	7050134	NC605905	NC605908	NC605907	NC605907
0V-616-555		GTP605D53	JPF605D53	JTP605D53A	GPF605D53B	GPF605D53C	FD60283	DF28403	AF60876	CNC605048	GUL605150	LL603884	LL603884	7050134	NC605905	NC605906	NC605907	NC605907

THREAD GUIDE
MACHINE : OV-604

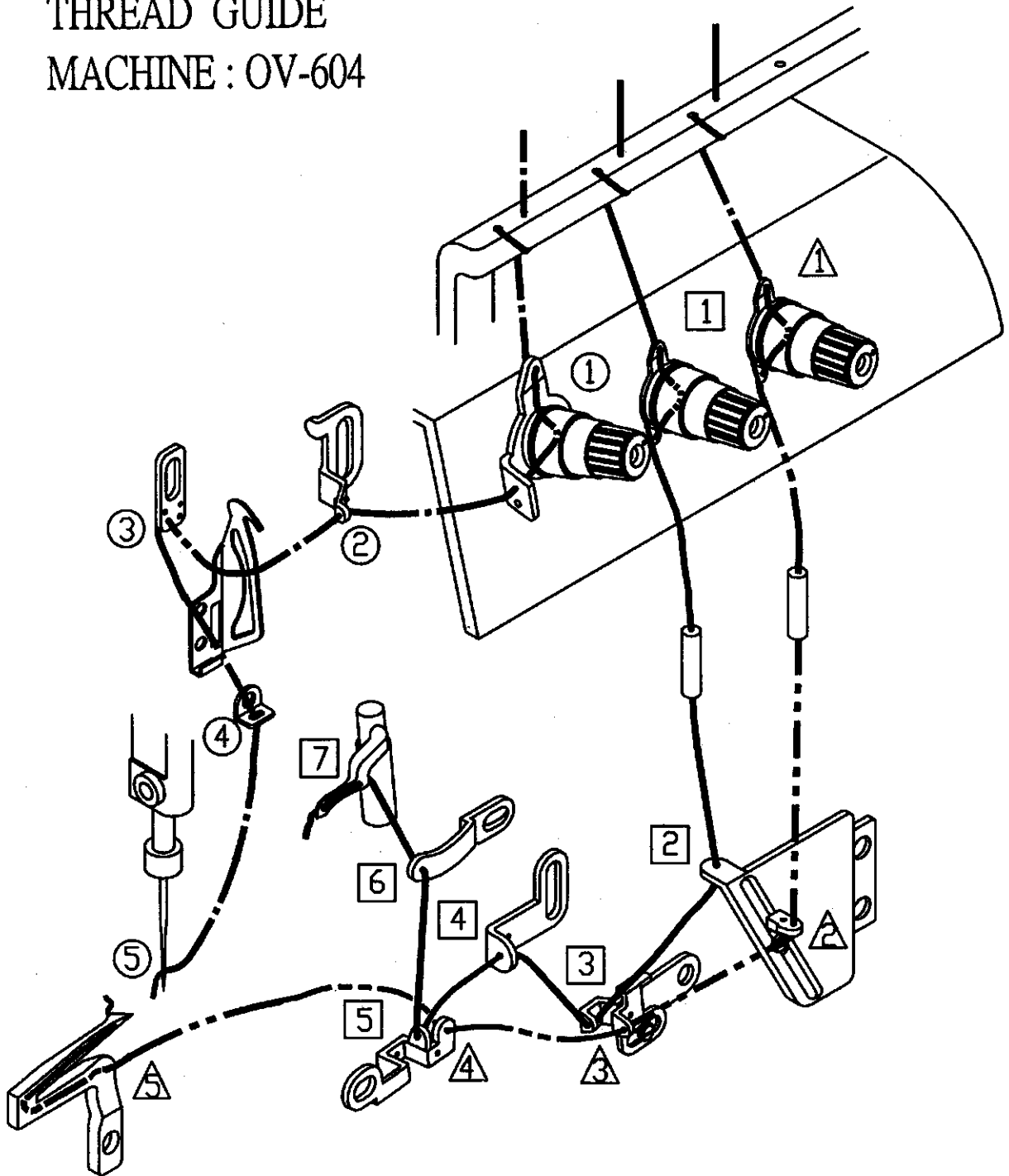

THREAD GUIDE
MACHINE : OV-614

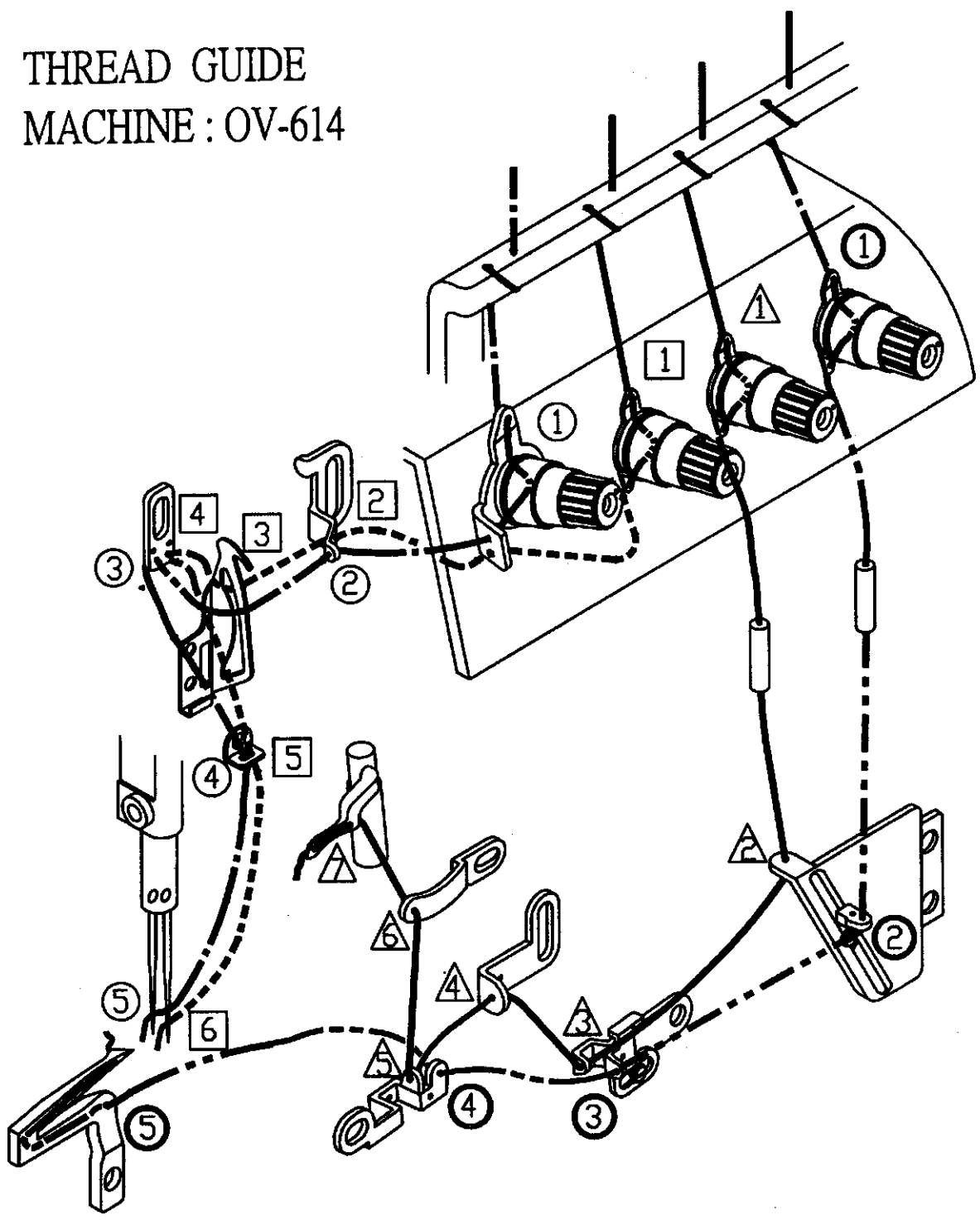

THREAD GUIDE
MACHINE : OV-616

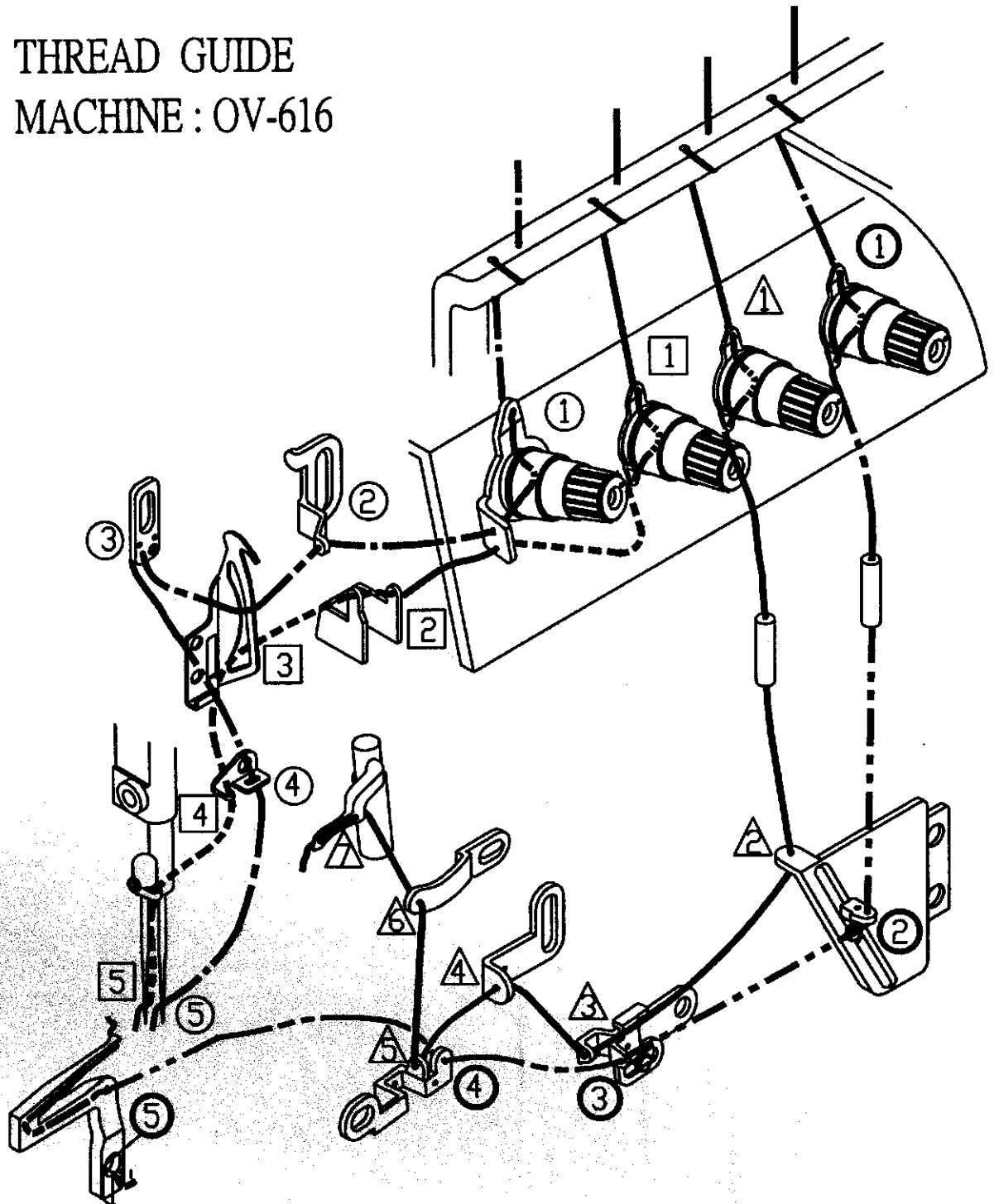

APP.2

THREAD GUIDE
MACHINE : OV-643

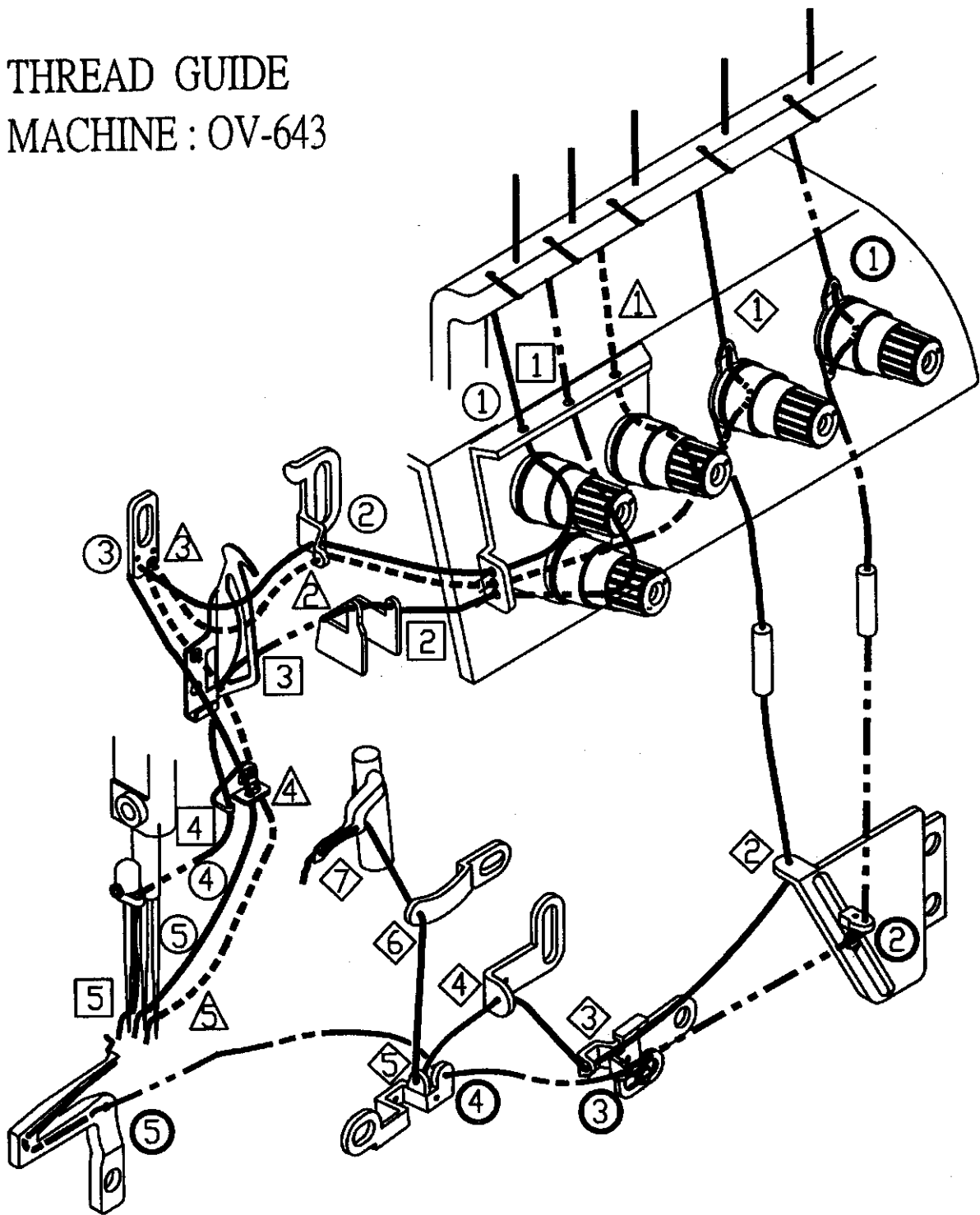

APP.2

(2) Dimensions for Fully Submerged Mounting

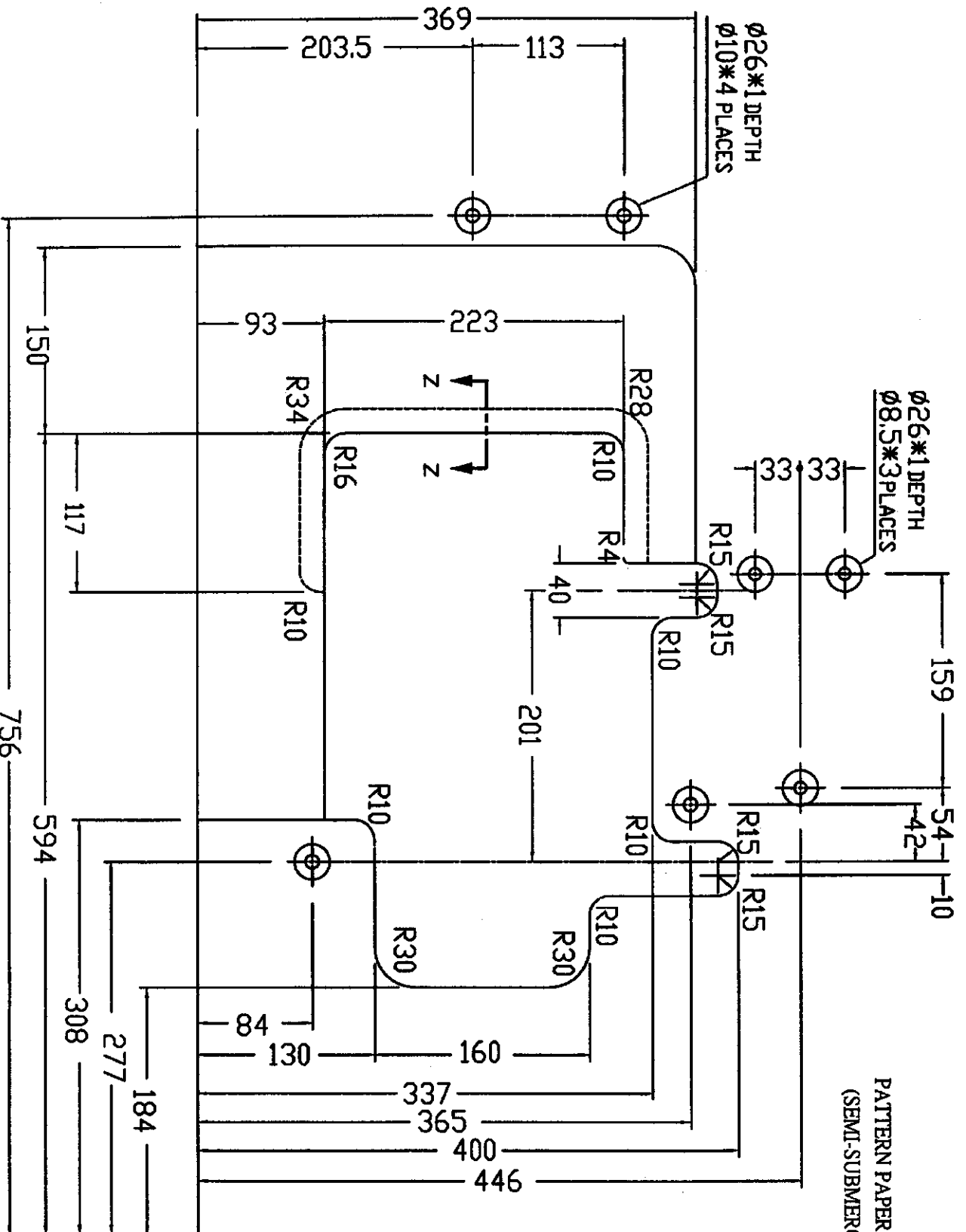

PATTERN PAPER FOR TABLE CUT-OUT
(SEMI-SUBMERGED INSTALLATION)