

List of Parts  
For

**CONSEW**

Model 754R



C O S O L I D A T E D   S E W I N G   M A C H I N E   C O R P .

28010	Arm shaft
28012	Cam
28013	Needle crank position set screw (large)
28014	Arm shaft bushing (front)
28015	Arm shaft bushing (rear)
28016	Arm shaft bushing (front) washer
28017	Machine pulley
28018	Machine pulley adjusting screw
28019	Machine pulley key
28020	Arm shaft bushing set screw (front)
28021	Arm shaft bushing set screw (rear)
28022	Thread take up lever
28022-A	Thread take up lever thread eyelet bushing
28023	Thread take up lever hinge stud
28024-A	Thread take up lever hinge stud set screw
28025	Thread take up lever roller
28026	Thread take up lever roller hinge screw
28027	Machine pulley set screw
28029	Needle bar
28030	Needle bar connecting stud
28031	Needle bar connecting stud set screw
28032	Needle crank position set screw (small)
28034	Needle bar rock frame
28035	Needle bar rock frame stud (upper)
28036	Needle bar rock frame stud (large)
28037	Needle bar rock frame stud (small)
28038	Needle bar rock frame guide
28039	Needle bar connecting link
28040	Needle bar connecting link stud set screw
28041	Needle bar rock frame stud (small) set screw
28042	Needle bar rock frame stud (large) set screw
28043	Foot lifter lifting lever set screw
28506	Needle bar rock frame stud (lower)
28045	Needle bar rock frame stud washer
1393	Presser bar
28507	Presser bar lifting bracket
28049	Presser bar position guide bracket
28050	Presser bar bushing (lower)
28051	Tension releasing bar
28052	Tension releasing lever
28054	Presser bar spring
28055	Presser bar screw nut

28058	Belt guard plate set screw
28513	Presser foot
6025	Presser foot set screw
28060	Lever hinge screw
28061	lever supporting plate
28062	Feed forked connection
28063	Feed and feed lifting eccentric
28064	Feed regulating bar
28065	Feed regulating bar stud
28066	Feed forked connection slide block
28067	Feed regulating collar
28068	Feed regulating collar set screw
28070	Feed forked connection slide block hinge screw nut
28073	Feed rock shaft
28074	Feed rock shaft stud screw
28075	Feed rock shaft crank connection
28076	Set screw for 28075
28077	Belt guard body
28078	Belt guard fitting bar
28079	Belt guard plate
28080	Belt guard body set screw
28083	Shuttle race body
28084	Shuttle race back
28085	Shuttle race back spring
28086	Hook cover
28087	Hook cover spring
28088	Hook cover spring set-pin
28089	Shuttle race body set screw
28090	Bed slide
28091C	Shuttle hook complete
28091-1	Shuttle frame
28091-2	Shuttle cylinder
28091-3	Shuttle cylinder set-pin
28091-4	Shuttle cylinder set spring
28091-5	Shuttle cylinder set spring set screw
28091-6	Thread regulating spring
28091-7	Set screw for 28091-6
28091-8	Set screw for 28091-7
28092	Bobbin
28093	Oil wick

4094	Set screw for 28095
28095	Washer for 28098
28096	Oscillating rock shaft
28097	Oscillating rock shaft hinge pin bushing
28098	Oscillating rock shaft hinge pin
28099	Oscillating rock shaft pin
28100	Washer for 28101
28101	Crank connecting rod
28102	Crank connecting rod cam
28103	Set screw for 28102
28104	Set screw for 28105
28105	Oscillating shaft crank
28106	Oscillating shaft crank slide block
28107	Slide block pin screw
28108	Set ring for 28102
28109	Rotating hook shaft
28110	Rotating hook shaft bushing (front)
28111	Rotating hook shaft bushing (rear)
28112	Rotating hook shaft collar
28113	Rotating hook shaft bushing set screw (front & rear)
28114	Shuttle driver
28116	Feed lifting rock shaft
28119	Feed dog
28120	Set screw for 28119
28121	Throat plate
28122	Set screw for 28121
28123	Feed bar
28124	Feed bar connection
28125	Feed bar fittings
28126	Feed bar connection hinge pin (upper)
28127	Feed bar connection hinge pin (lower)
28138	Set screw for 28177

28148	Upper feed rock shaft
28151	Connection (A) for 28148
28152	Connection (B) set screw for 28148
28153	Connection (B) for 28148
28154	Upper feed crank connection rod
28155	Hinge screw for 28154
28157	Thread guide (center) of face plate
28158	Thread guide (lower) of face plate
28161	Feed regulating plate
28162	Feed regulating collar
28163	Feed regulating lever pin screw
28164	Feed regulating knob
28508	Upper feed connection
28510	Arm cover (front)
28504	Face plate
28170	Thread controller spring stop
28171	Take-up spring
28172	Take-up spring (extra)
28173	Side plate (arm)
28174	Side plate (bed)
28175	Arm cap
28176	Foot lifter lifting lever
28177	Foot lifter lifting lever (small)
28178	Pin for 28176
28179	Spring for 28176
28180	Washer for 28176
28181	Bobbin winder bracket
28182	Bobbin winder shaft stop
28183	Bobbin winder hinge screw
28184	Bobbin winder shaft driving roller
28185	Bobbin winder shaft
28186	Bobbin winder returning spring
28187	Bobbin winder lever spring
28188	Bobbin winder lever spring stop
28189	Bobbin winder lever

28190	Bobbin winder regulating lever spring
28191	Bobbin winder lever shaft
28192	Bobbin winder driving collar
28193	Bobbin winder rubber ring
28198	Tension stud (lower)
28199	Tension washer
28200	Tension disc
28201	Tension oil pad
28202	Tension spring
28203	Tension regulating thumb nut
28204	Tension stud nut
28205	Tension stud washer
28206	Tension thumb nut stopper
28208	Stop ring for foot lifter lifting lever
28231	Bobbin winder adjusting bar
1402	Presser bar screw
1424	Face plate thread guide (upper)
1439	Needle
4094	Set screw for 28095
28043	Set screw for 28063
4134	Set screw for 28192
4839	Stop ring for 28191
2067	Set screw for 28050
100914	Set screw for 28038
8040	Set screw for 28186
8040	Set screw for 28052
"	Set screw for 28133
"	Set screw for 1424
"	Set screw for 28158
"	Set screw for 28187
"	Set screw for 28170
10597	Set screw for 28190
10629	Screw for 28190

10652	Pin-screw nut for 13055 & tension bracket
10723	Oil wick presser for 28093
10794	Oil cup
147468	Upper feed driving rock shaft stop collar
100624	Set screw for 147468
11067	Nut for 28157
11073	Set screw for 28051
11426	Stop ring for 28035
12418	Set screw for 28175
"	Set screw for 28173
"	Set screw for 28174
13055	Presser bar lifter
13134	Hinge screw for 28167
13330-4	Set screw for 28181
17046	Set screw for 28161
17095	Hinge screw stop ring for 28101
"	Stop ring for 28107
"	Stop ring for 28126 & 28127
18065	Set screw for 28049
"	Set screw for 28504
20018	Tension stud
20019	Tension disc
20020	Tension release washer
20023	Washer for tension spring
20024	Tension spring
20025	Tension bracket
20171	Rubber bung for arm

20021	Tension regulating thumb nut (A)
20022	Tension regulating thumb nut (B)
27060	Tension release washer
27061	Tension thumb nut
27062	Releasing stopper collar for 27061
27174	Set screw for 28188
30025	Washer for 28052
31021	Set screw for 28507
100914	Set screw for 28038
31204	Set ring for 28126
30066	Set screw for 28061
35024	Needle clamp body
35056	Feed regulating thumb nut (B)
50003	Set screw for 35024
2067	Set screw for 28184
100456	Set screw for 28112
"	Set screw for feed driving rock shaft stop collar
"	Set screw for feed lifting rock shaft stop collar
28006	Bolt for head to be fitted on table
28007	Nut for head to be fitted on table
28008	Washer for head to be fitted on table
8132	Accessories box
8118	Screw driver (large)
8120	Screw driver (medium)
8121	Screw driver (small)
28092	Bobbin
1439	Needle
11193	Oil (large)
8125	Oiler
10942	Needle bar
11969	Wrench 2.5 m/m
15572	" 3 "
15571	" 4 "
1870	" 5 "
1871	" 6 "



13079

Lever chain

35225

Opener for cylinder

35254

Thread unwinder complete

50134

Taper pin for Suttle driver

Consaw Model  
754R

3

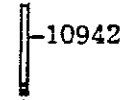
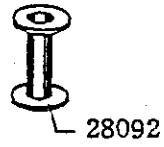

1439

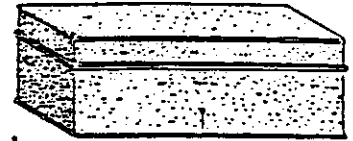

8125

8132

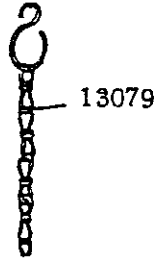

13079

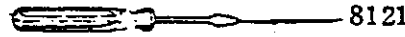

8121



8120

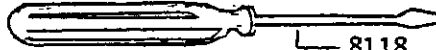

8118



11193

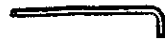

11969 (2.5m/m)

15572 (3m/m)

15571 (4m/m)

1870 (5m/m)

1871 (6m/m)

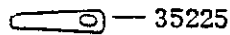

35225

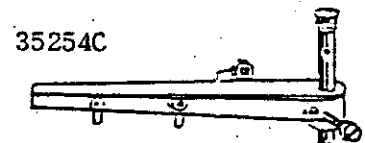
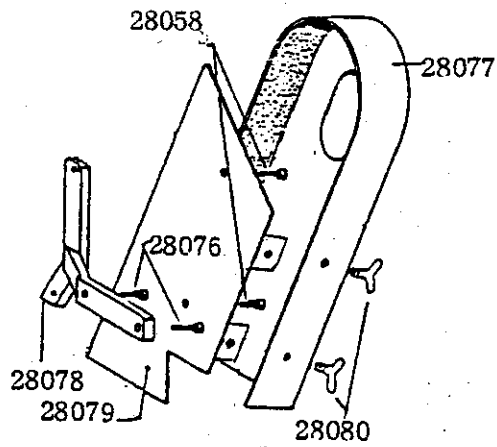

35254C

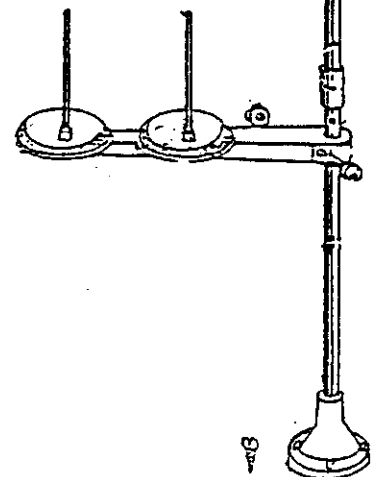

28006

28008

28007