

CONSEW

PARTS LIST

FOR

MODEL 387RB

384RB

THREAD TAKE-UP LEVER, NEEDLE BAR MECHANISM
FOR MODEL 387RB ,384RB

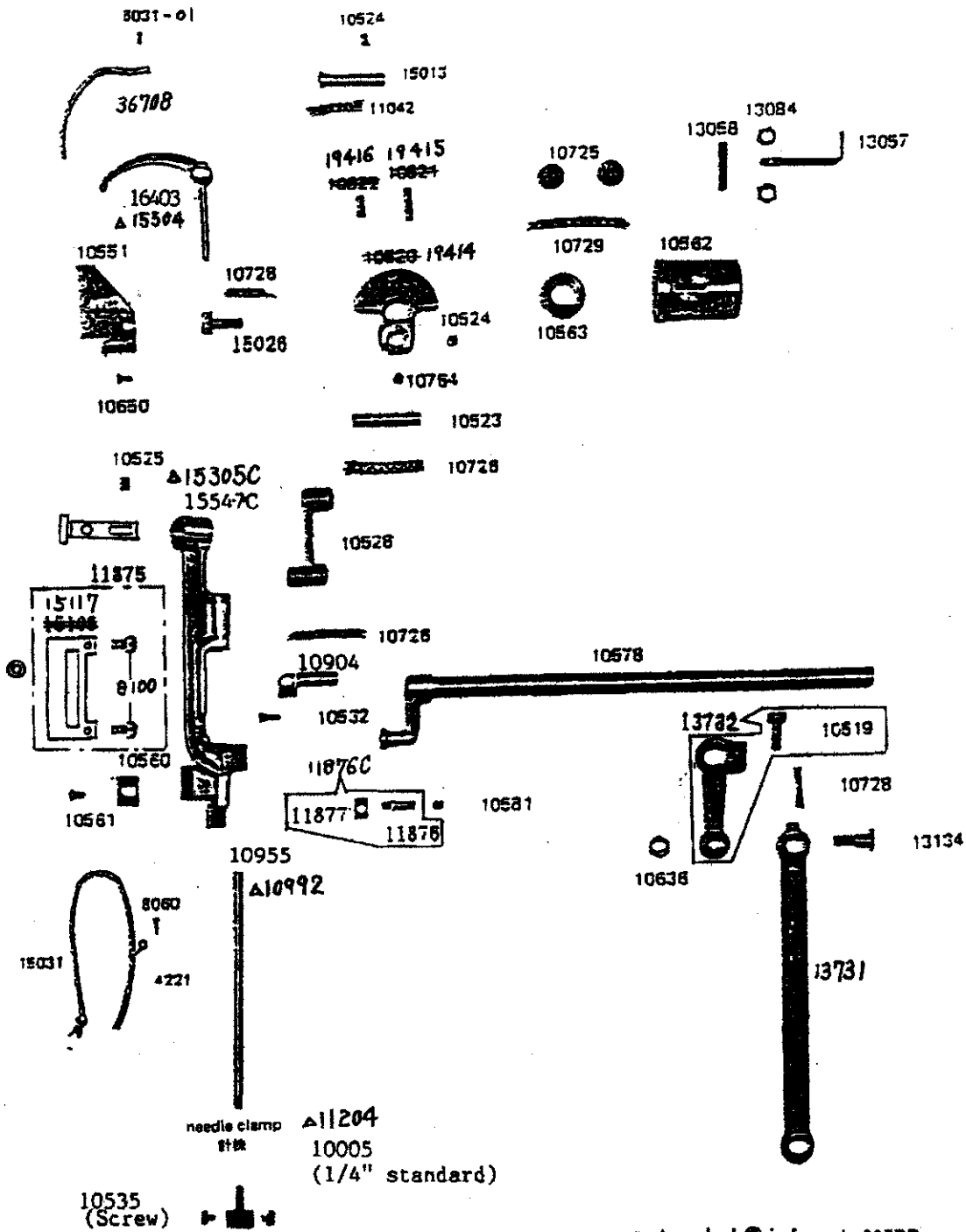

part marked ⊙ is for only 387RB
part marked △ is for only 384RB

THREAD TAKE-UP LEVER, NEEDLE BAR MECHANISM

FOR MODEL 387RB ,384RB

10712

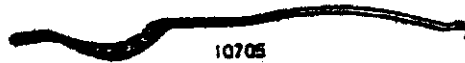
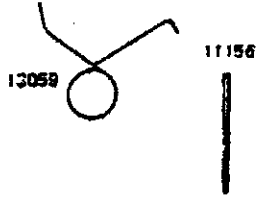
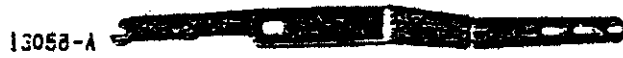

19035



15038

15039

15037

for $\frac{1}{4}$ " (6.4mm)

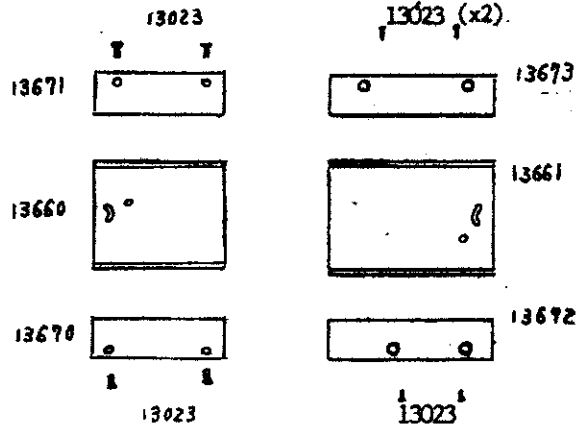

**THREAD GUIDE, THREAD TENSION, FEED DRIVING ROCK SHAFT
FOR MODEL 387RB ,384RB**

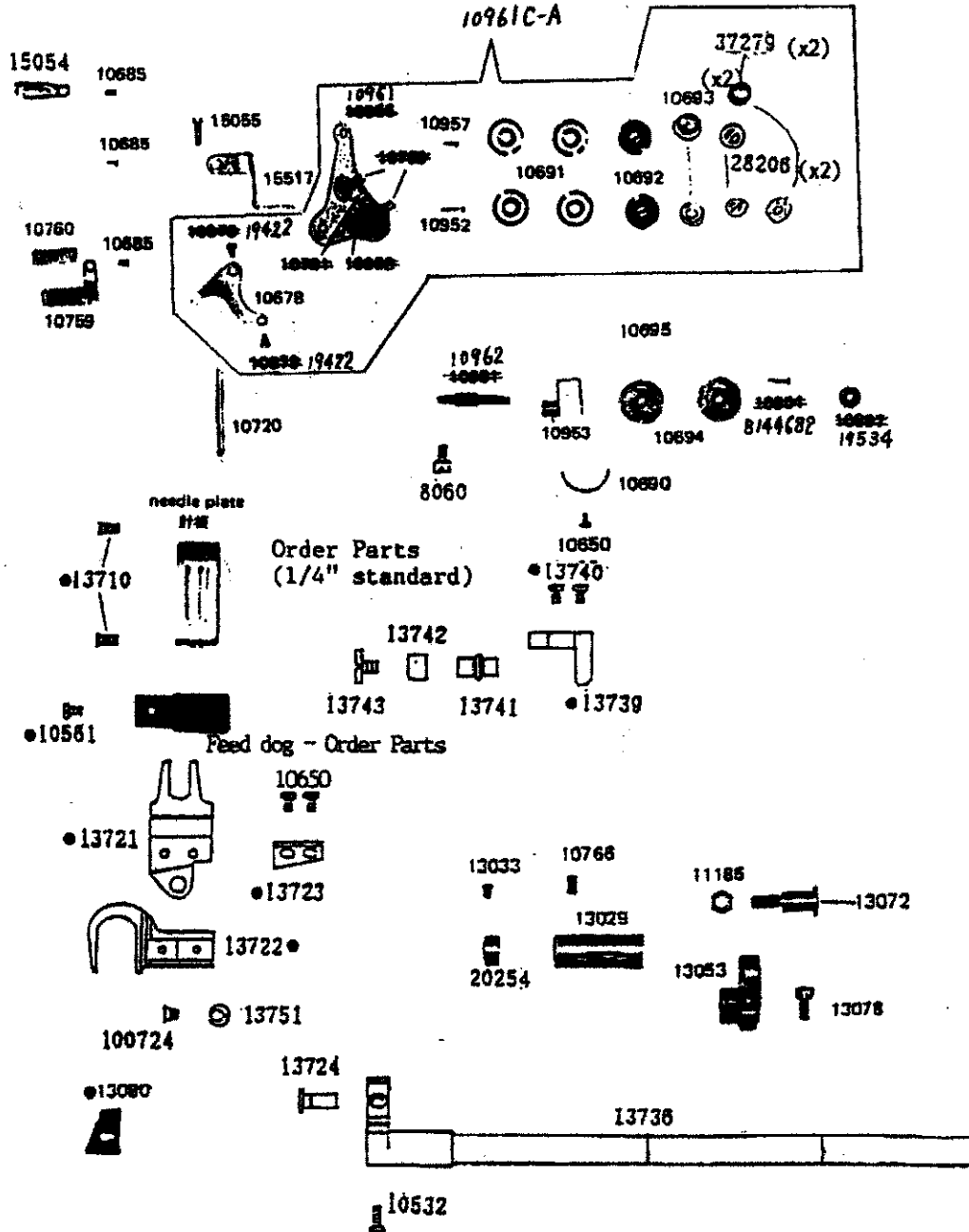

PRESSER BAR, LIFTING ROCK SHAFT, INNER PRESSER FOOT

FOR MODEL 387RB ,384RB

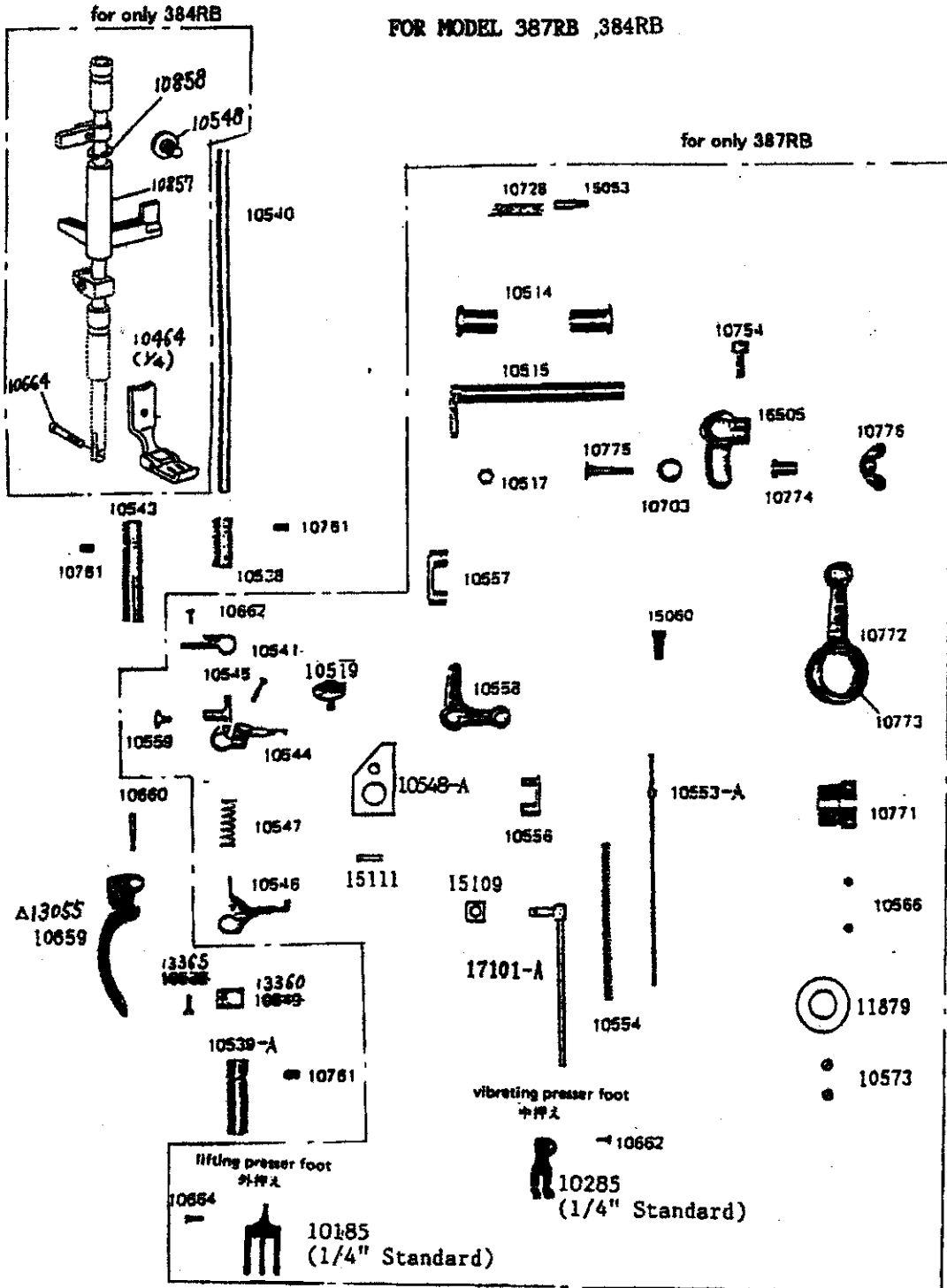

LOWER SHAFT, HOOK
FOR MODEL 387RB ,384RB

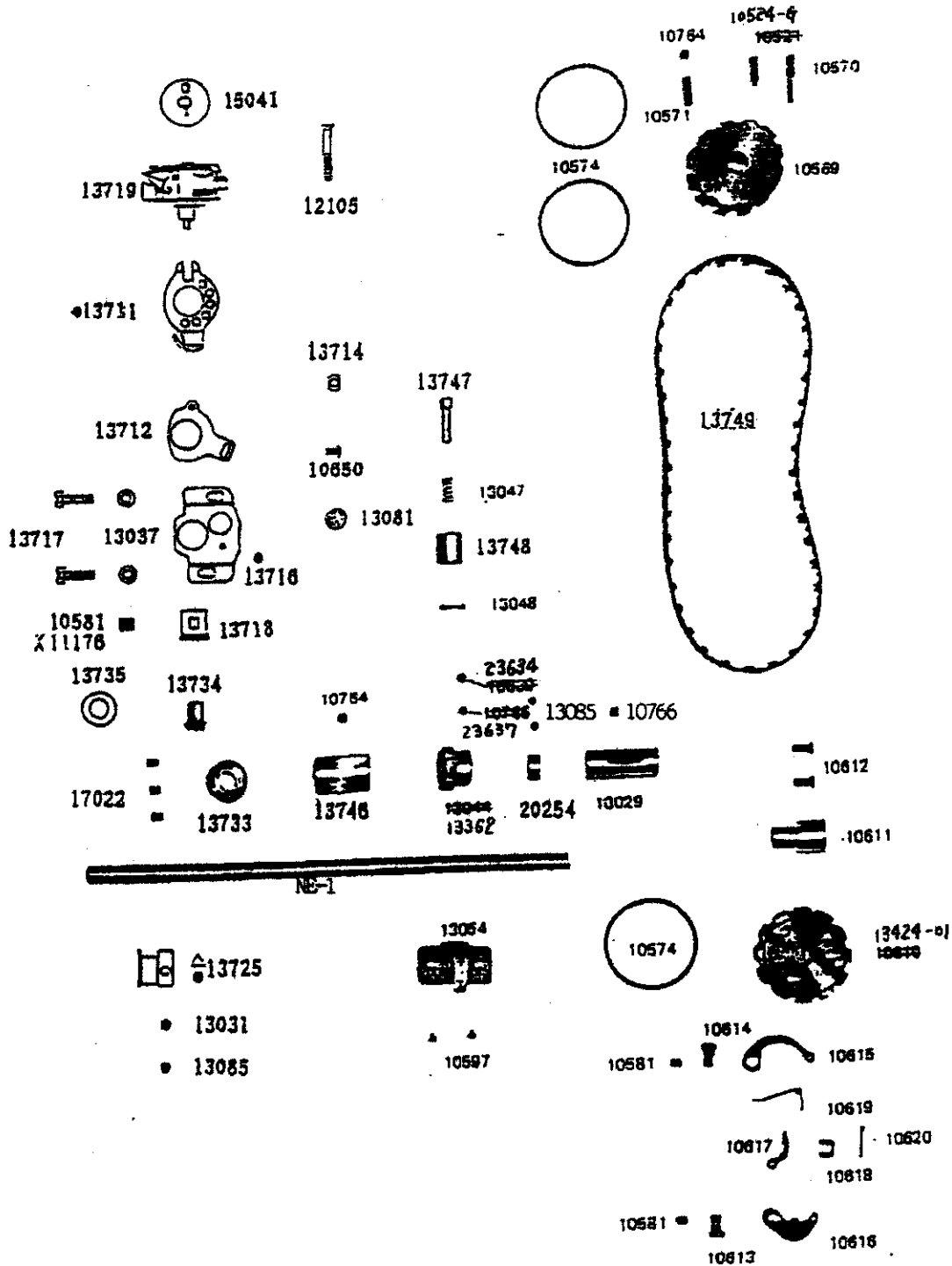

REVERSE STITCHING MECHANISM
FOR MODEL 387RB ,384RB

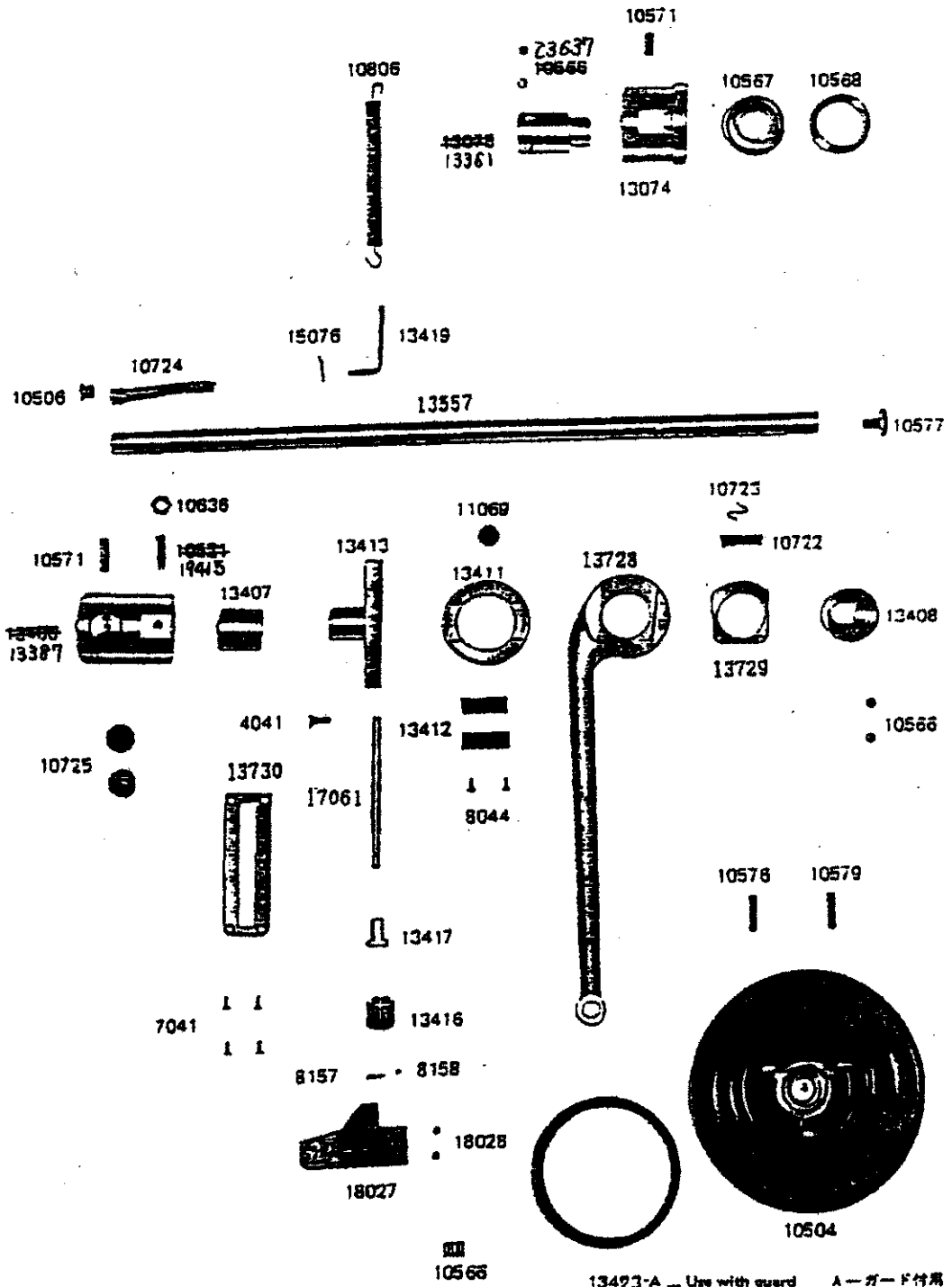

13493-A ... Use with guard A - ガード付用
B ... Use without guard B - ガード不用

UPPER PLATE, LUBRICATION SYSTEM

FOR MODEL 387RB ,384RB

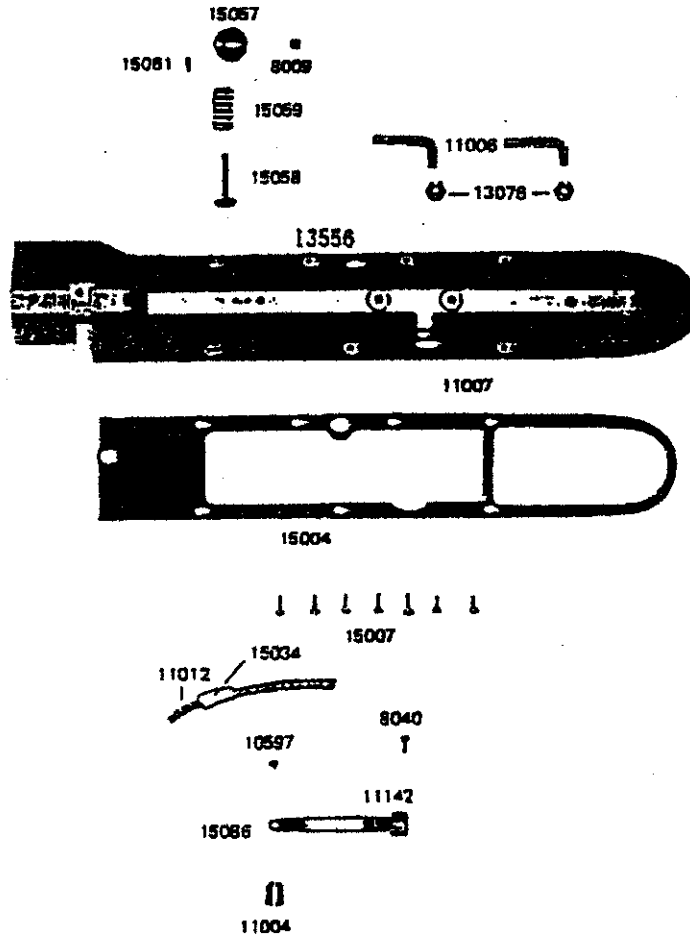

BELT COVER
FOR MODEL 387RB ,384RB

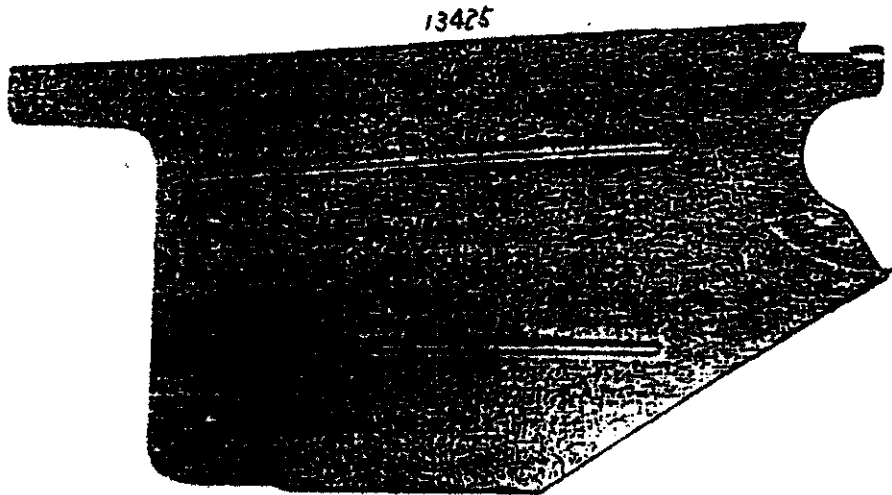

13427



50103



50099



14024



50103



50099



14024



6339



11142



10581



11142



10581



ACCESSORIES

FOR MODEL 387RB ,384RB

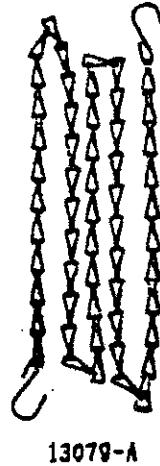
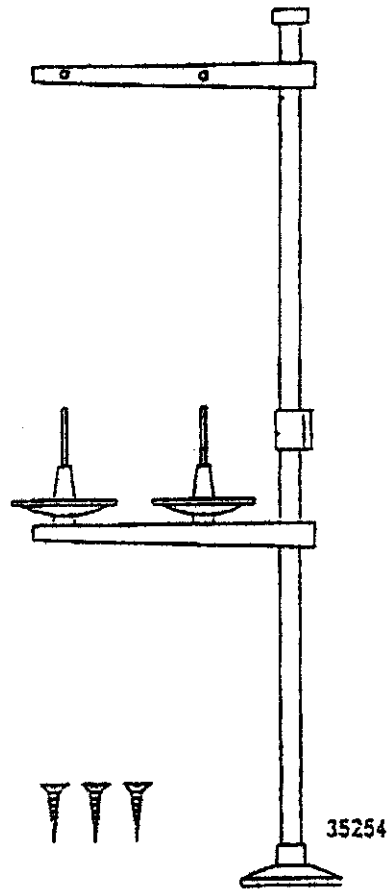
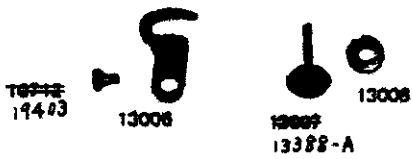
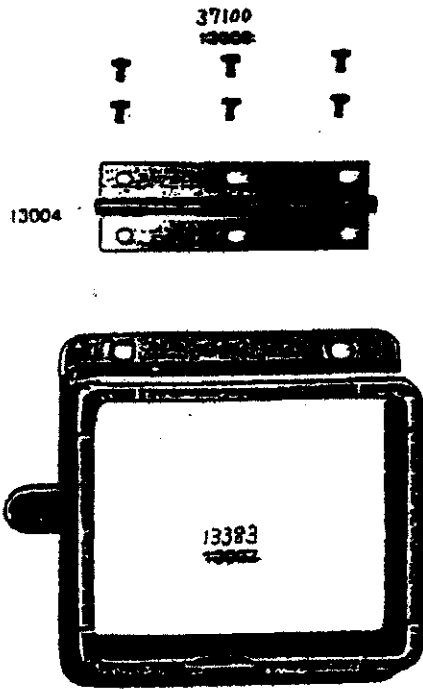

ACCESSORIES

FOR MODEL 387RB ,384RB

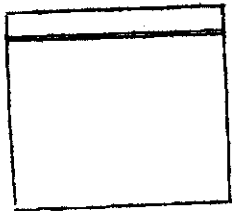

8132-B



15041

6332



10748

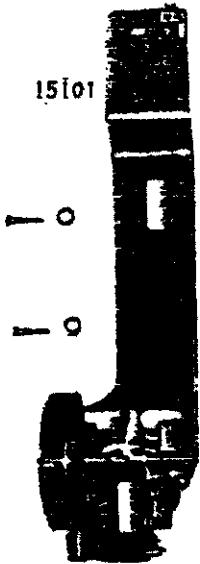

15101



3118



3120



8121



11969



50285



8125

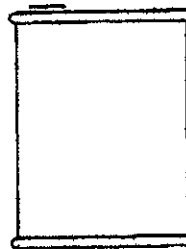

11193

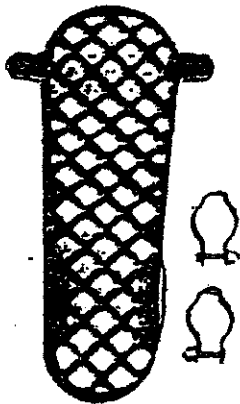

13094

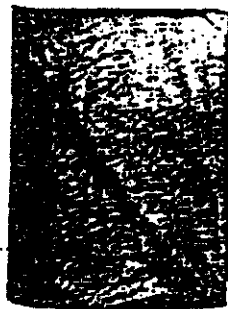



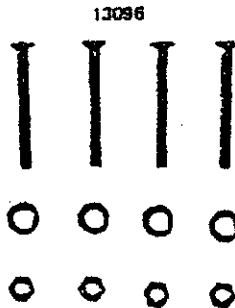

8124







13096

PARTS
FOR MODEL 387RB

GAUGE		ゲージ部品 (PARTS)				
		針板 needle plate	送り歯 feed dog	針挟 needle clamp	中押え ribbing presser foot	外押え filling presser foot
寸法 (GAUGE)						
in	mm					
1/8"	3.2	13650	13651	10002	10282	10182
1/4"	6.4	13652	13653	10005	10285	10185
3/8	9.5	13654	13655	10007	10287	10187
1/2	12.7	13656	13657	10009	10289	10189

FOR MODEL 384RB

GAUGE		ゲージ部品 (PARTS)			
		針板 needle plate	送り歯 feed dog	針挟 needle clamp	押え金 presser foot
寸法 (GAUGE)					
in	mm				
1/4"	6.4	13652	13653	11204	10485